





# ROBO Cylinder® vs. Single-Axis Robot

Please refer to the table below for the “ROBO Cylinder” and “Single-Axis Robot” categories.



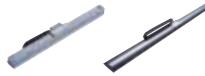

Category	Listed Catalog	Feature	Models	Specifications			
				Horizontal payload (kg)	Max. speed (mm/s)	Positioning repeatability (mm)	Max. stroke (mm)
ROBO Cylinders	<b>ROBO Cylinder General Catalog</b> 	Ideal small electric cylinders for replacing air cylinders.	<b>Mini ROBO Cylinders</b> 	~20	~380	±0.02~	~288
			<b>ROBO Cylinders</b> 	~80	~1800	±0.01~	~1200
Single-Axis Robots	<b>Individual product catalogs</b>	Medium to large size electric actuators featured in high speed, high precision, high rigidity, and heavy payload applications.	<b>Single-Axis Robots</b> 	~150	~2500	±0.005~	~3000
			<b>Linear Servo Actuators</b> 	~120	~2500	±0.005~	~4155

\* There are no models that satisfy both the horizontal payload and maximum speed in the above specifications.

## IAI Robots/Actuators NOT listed in this catalog

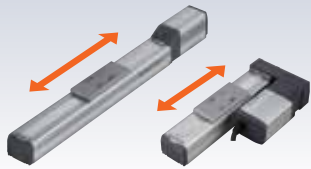
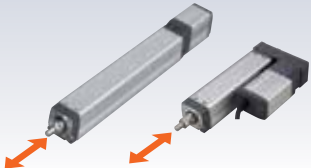
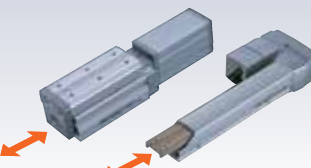
<b>Single-Axis Robots</b> ISB/ISPB 	<b>Dustproof Single-Axis Robots</b> ISDB/ISPDB 	<b>Belt Single-Axis Robots</b> IF 	<b>Rotational Single-Axis Robots</b> RS 	<b>Shaft Linear Servo</b> LSA 	<b>Large Linear Servo</b> LSA 
<b>Cleanroom Single-Axis Robots</b> ISDBCR 	<b>Cleanroom SCARA Robots</b> IX-NNC 	<b>Splash-Proof SCARA Robots</b> IX-NNW 	<b>Ultra-Compact/Compact SCARA</b> IX-NNN 	<b>Cartesian Robots</b> ICSPA3/ICSPA3 	<b>Tabletop Robots</b> TT-A2/A3 

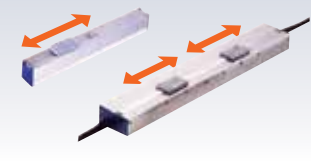
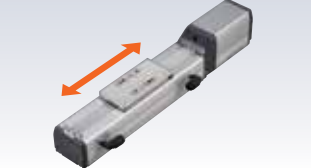
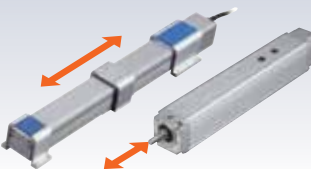
# ROBO Cylinder® Products Overview

Type	Form	Applications/Features	See Page
Slider Type		<ul style="list-style-type: none"> <li>Move an object in the horizontal direction</li> <li>Move over a long distance</li> </ul>	P.1
Rod Type		<ul style="list-style-type: none"> <li>Move an object in the vertical direction</li> <li>Move an object with chucks, etc.</li> <li>Hold a work part while pressing it against something</li> <li>Press-fit a work part</li> </ul>	P.145
Table Type/ Arm Type/ Flat Type		<ul style="list-style-type: none"> <li>Move an object in the vertical direction</li> <li>When a moment load is applied</li> </ul>	P.301
Gripper Type/ Rotary Type		<ul style="list-style-type: none"> <li>Grip and lift a work part</li> <li>Centering</li> <li>Change the direction of a work part</li> <li>Perform fine positioning for indexing</li> </ul>	P.371
Linear Servo Type		<ul style="list-style-type: none"> <li>Want to transfer a light object at high speed</li> </ul>	P.417
Cleanroom Type		<ul style="list-style-type: none"> <li>Used in a cleanroom running a liquid crystal or semiconductor production line, etc.</li> </ul>	P.443
Dustproof/ Splash-Proof		<ul style="list-style-type: none"> <li>Used with an automobile or food manufacturing system or in other location subject to dust and water splashes</li> </ul>	P.493
Controllers		<ul style="list-style-type: none"> <li>Wide-ranging models are available, from the ultra-simple type that can be operated under the same control used for solenoid valves, to the network-ready high-functional type; select one that best suits your specific application.</li> </ul>	P.523

# PRODUCT INDEX ①

## Product Overview

Model Selection (overview) ..... Pre-11  
 Basic System Configuration ..... Pre-16  
 Check Specifications ..... Pre-17  
 How to Read the Catalog ..... Pre-35  
 Explanation of Items in This Catalog for Model Selection ..... Pre-37

Notes on Specifications in this Catalog (All Models) ..... Pre-39  
 Application Examples ..... Pre-45  
 Description of Models ..... Pre-47  
 Description of Functions ..... Pre-49  
 CT Effects of Motorized Actuator ..... Pre-53

## SLIDER TYPE

▶ P.1

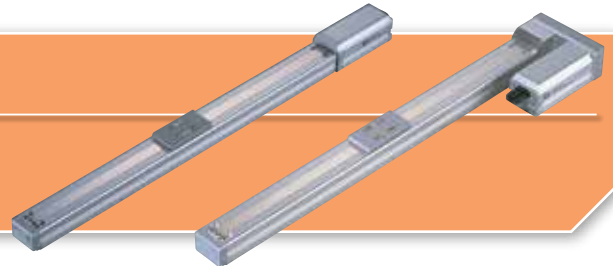

### ▶ Pulse Motor Type

RCP□ series

RCP4

<b>NEW</b>	Standard type	52mm width	RCP4-SA5C	... 3
		58mm width	RCP4-SA6C	... 5
		73mm width	RCP4-SA7C	... 7



<b>NEW</b>	Side-mounted motor type	52mm width	RCP4-SA5R	... 9
		58mm width	RCP4-SA6R	... 11
		73mm width	RCP4-SA7R	... 13



Mini type	22mm width	RCP3-SA2AC	.. 15
	28mm width	RCP3-SA2BC	.. 17



Standard type	32mm width	RCP3-SA3C	... 19
	40mm width	RCP3-SA4C	... 21
	50mm width	RCP3-SA5C	... 23
	60mm width	RCP3-SA6C	... 25



Mini type w/ side-mounted motor	22mm width	RCP3-SA2AR	.. 27
	28mm width	RCP3-SA2BR	.. 29



Side-mounted motor type	32mm width	RCP3-SA3R	... 31
	40mm width	RCP3-SA4R	... 33
	50mm width	RCP3-SA5R	... 35
	60mm width	RCP3-SA6R	... 37



RCP3

RCP2

Steel base	60mm width	RCP2-SS7C	... 39
	80mm width	RCP2-SS8C	... 41



High-speed type	80mm width	RCP2-HS8C	... 43
-----------------	------------	-----------	--------



Side-mounted motor type steel base	60mm width	RCP2-SS7R	... 45
	80mm width	RCP2-SS8R	... 47



High-speed type w/side-mounted motor	80mm width	RCP2-HS8R	... 49
--------------------------------------	------------	-----------	--------



Belt type	58mm width	RCP2-BA6 (BA6/BA6U)	... 51
	68mm width	RCP2-BA7 (BA7/BA7U)	... 53



### ▶ Pulse Motor Controller-Integrated Type

ERC□ series

ERC3

<b>NEW</b>	Standard type	50mm width	ERC3-SA5C	... 55
		74mm width	ERC3-SA7C	... 57
		50mm width	ERC3D-SA5C (Stainless steel sheet specification)	... 59



Standard type	73mm width	ERC3D-SA7C (Stainless steel sheet specification)	... 61
---------------	------------	--	--------

ERC2

Standard type	58mm width	ERC2-SA6C	... 63
	68mm width	ERC2-SA7C	... 65



## ▶ Servo Motor Type (24V)

RCA  
seriesR  
C  
A  
2

Mini type 20mm width RCA-SA2AC .. 67

NEW

Standard type 32mm width RCA-SA3C ... 69  
40mm width RCA-SA4C ... 71  
50mm width RCA-SA5C ... 73  
60mm width RCA-SA6C ... 75Mini type w/  
side-mounted  
motor 20mm width RCA-SA2AR .. 77

NEW

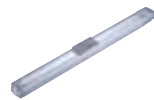
Side-mounted  
motor type 32mm width RCA-SA3R ... 79  
40mm width RCA-SA4R ... 81  
50mm width RCA-SA5R ... 83  
60mm width RCA-SA6R ... 85Standard type 40mm width RCA-SA4C ..... 87  
52mm width RCA-SA5C ..... 89  
58mm width RCA-SA6C ..... 91Built-in type,  
aluminum base 40mm width RCA-SA4D .... 93  
52mm width RCA-SA5D .... 95  
58mm width RCA-SA6D .... 97Built-in type,  
steel base 40mm width RCA-SS4D ..... 99  
52mm width RCA-SS5D ... 101  
58mm width RCA-SS6D ... 103Side-mounted  
motor  
type 40mm width RCA-SA4R .... 105  
52mm width RCA-SA5R .... 107  
58mm width RCA-SA6R .... 109R  
C  
A

## ▶ Servo Motor Type (100/200V)

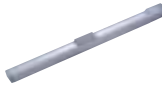
RCS  
seriesR  
C  
S  
3Standard type 80mm width RCS3-SA8C ... 111  
80mm width RCS3-SS8C ... 113Side-mounted  
motor type 80mm width RCS3-SA8R ... 115  
80mm width RCS3-SS8R ... 117Standard type 40mm width RCS2-SA4C ... 119  
52mm width RCS2-SA5C ... 121  
58mm width RCS2-SA6C ... 123  
73mm width RCS2-SA7C ... 125

Steel base 60mm width RCS2-SS7C ... 127

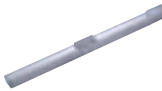
Built-in type 40mm width RCS2-SA4D .. 129  
52mm width RCS2-SA5D .. 131  
58mm width RCS2-SA6D .. 133Side-mounted  
motor type 40mm width RCS2-SA4R ... 135  
52mm width RCS2-SA5R ... 137  
58mm width RCS2-SA6R ... 139  
73mm width RCS2-SA7R ... 141Side-mounted  
motor type  
steel base 60mm width RCS2-SS7R ... 143R  
C  
S  
2

CONTINUED ON THE NEXT PAGE

# PRODUCT INDEX<sup>②</sup>

## Rod Type

► P.145



### ► Pulse Motor Type

RCP□  
series

RCP4

Radial cylinder Standard type

**NEW**



52mm width RCP4-RA5C ... 147  
61mm width RCP4-RA6C ... 149

Radial cylinder Side-mounted motor type

**NEW**



52mm width RCP4-RA5R ... 151  
61mm width RCP4-RA6R ... 153

RCP3

Mini type

**NEW**



22mm width RCP3-RA2AC ... 155  
28mm width RCP3-RA2BC .. 157

Mini type w/ side-mounted motor

**NEW**



22mm width RCP3-RA2AR .. 159  
28mm width RCP3-RA2BR .. 161

RCP2

Coupled type



25mm width RCP2-RA2C ... 163  
35mm width RCP2-RA3C ... 165

High-thrust type



85mm width RCP2-RA8C ... 167  
85mm width RCP2-RA8R ... 169  
100mm width RCP2-RA10C .. 171

Short-length type



45mm width RCP2-SRA4R .. 173

Short-length type w/single guide

45mm width RCP2-SRGS4R .. 175

Short-length type w/double guides

45mm width RCP2-SRGD4R .. 177

### ► Pulse Motor Controller-Integrated Type

ERC□  
series

ERC3

Standard type

**NEW**



45mm width ERC3-RA4C ... 179  
64mm width ERC3-RA6C ... 181

ERC2

Standard type



58mm width ERC2-RA6C ... 183  
68mm width ERC2-RA7C ... 185

Single guide type



58mm width ERC2-RGS6C .. 187  
68mm width ERC2-RGS7C .. 189

Double guide type



58mm width ERC2-RGD6C .. 191  
68mm width ERC2-RGD7C .. 193

### ► DC Motor Type

RCD□  
series

RCD

Mini Cylinder

**NEW**



12mm width RCD-RA1D .... 195

### ► Servo Motor Type (24V)

RCA□  
series

RCA2

Mini type

**NEW**



18mm width RCA2-RA2AC .. 197  
18mm width RCA2-RA2AR .. 199

Mini type, nut mounting



28mm width RCA2-RN3NA .. 201  
34mm width RCA2-RN4NA .. 203

Mini type, tapped hole mounting



28mm width RCA2-RP3NA .. 205  
34mm width RCA2-RP4NA .. 207

Mini type, single guide



28mm width RCA2-GS3NA .. 209  
34mm width RCA2-GS4NA .. 211

Mini type, double guide



28mm width RCA2-GD3NA .. 213  
34mm width RCA2-GD4NA .. 215

## Slider Type

## Rod type

Table Type  
Gripper Type/Rotary Type  
Linear Servo TypeCleanroom Type  
Dustproof/Splash-Proof Type  
Controllers

RCA2

Mini slide unit type  60mm width RCA2-SD3NA . 217  
72mm width RCA2-SD4NA . 219

Standard type  ø32mm RCA-RA3C ... 221  
ø37mm RCA-RA4C ... 223

Built-in type  ø32mm RCA-RA3D ... 225  
ø37mm RCA-RA4D ... 227

Side-mounted motor type  ø32mm RCA-RA3R ... 229  
ø37mm RCA-RA4R ... 231

Short-length type  45mm width RCA-SRA4R .. 233

RCA

Single guide type  ø32mm RCA-RGS3C .. 235  
ø37mm RCA-RGS4C .. 237  
ø32mm RCA-RGS3D .. 239  
ø37mm RCA-RGS4D .. 241

Short-length type w/single guide  45mm width RCA-SRG54R .. 243

Double guide type  ø32mm RCA-RGD3C .. 245  
ø37mm RCA-RGD4C .. 247  
ø32mm RCA-RGD3D .. 249  
ø37mm RCA-RGD4D .. 251  
ø32mm RCA-RGD3R .. 253  
ø37mm RCA-RGD4R .. 255

Short-length type w/double guide  45mm width RCA-SRGD4R .. 257

## ▶ Servo Motor Type (100/200V)

RCS□  
series

RCS2

Mini type, nut mounting  46mm width RCS2-RN5N .. 259  
**NEW**

Mini type, tapped hole mounting  46mm width RCS2-RP5N .. 261  
**NEW**

Mini type, single guide  46mm width RCS2-GS5N .. 263  
**NEW**

Mini type, double guide  46mm width RCS2-GD5N .. 265  
**NEW**

Mini slide unit type  94mm width RCS2-SD5N .. 267  
**NEW**

Standard type  ø37mm RCS2-RA4C .. 269  
55mm width RCS2-RA4C .. 271

Built-in type  ø37mm RCS2-RA4D .. 273

Short-length type  75mm width RCS2-SRA7BD . 275

RCS2

Side-mounted motor type  ø37mm RCS2-RA4R ... 277  
55mm width RCS2-RA5R ... 279

Ultra-high thrust type  130mm width RCS2-RA13R .. 281

Single guide type  ø37mm RCS2-RGS4C .. 283  
55mm width RCS2-RGS5C .. 285  
ø37mm RCS2-RGS4D .. 287

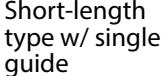
Short-length type w/ single guide  75mm width RCS2-SRG57BD 289

Double guide type  ø37mm RCS2-RGD4C .. 291  
55mm width RCS2-RGD5C .. 293  
ø37mm RCS2-RGD4D .. 295

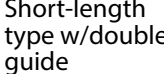
Short-length type w/double guide  75mm width RCS2-SRGD7BD 297

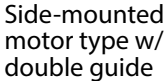
Side-mounted motor type w/ double guide  ø37mm RCS2-RGD4R .. 299

CONTINUED ON THE NEXT PAGE

# PRODUCT INDEX<sup>③</sup>

## Table Type

▶ P.301

### ▶ Pulse Motor Type

RCP□  
series

R  
C  
P  
3

	Standard type	36mm width	RCP3-TA3C ...	303
		40mm width	RCP3-TA4C ...	305
		55mm width	RCP3-TA5C ...	307
		65mm width	RCP3-TA6C ...	309
		75mm width	RCP3-TA7C ...	311

	Side-mounted motor type	36mm width	RCP3-TA3R ...	313
		40mm width	RCP3-TA4R ...	315
		55mm width	RCP3-TA5R ...	317
		65mm width	RCP3-TA6R ...	319
		75mm width	RCP3-TA7R ...	321

### ▶ Servo Motor Type (24V)

RCA□  
series

R  
C  
A  
2

	Mini compact type	32mm width	RCA2-TCA3NA	323
		36mm width	RCA2-TCA4NA	325

	Mini wide type	50mm width	RCA2-TWA3NA	327
		58mm width	RCA2-TWA4NA	329

	Mini flat type	61mm width	RCA2-TFA3NA	331
		71mm width	RCA2-TFA4NA	333

	Standard type	40mm width	RCA2-TA4C ...	335
		55mm width	RCA2-TA5C ...	337
		65mm width	RCA2-TA6C ...	339
		75mm width	RCA2-TA7C ...	341

	Side-mounted motor type	40mm width	RCA2-TA4R ...	343
		55mm width	RCA2-TA5R ...	345
		65mm width	RCA2-TA6R ...	347
		75mm width	RCA2-TA7R ...	349

R  
C  
A

	Arm type	40mm width	RCA-A4R ...	357
		52mm width	RCA-A5R ...	359
		58mm width	RCA-A6R ...	361

### ▶ Servo Motor Type (100/200V)

RCS□  
series

R  
C  
S  
2

	Mini compact Type	48mm width	RCS2-TCA5N ..	351
	<b>NEW</b>			

	Mini wide type	80mm width	RCS2-TWA5N..	353
	<b>NEW</b>			

	Mini flat type	95mm width	RCS2-TFA5N ..	355
	<b>NEW</b>			

R  
C  
S  
2

	Arm type	40mm width	RCS2-A4R ...	363
		52mm width	RCS2-A5R ...	365
		58mm width	RCS2-A6R ...	367

	Flat type	55mm width	RCS2-F5D ...	369
--	-----------	------------	--------------	-----

## Gripper Type

▶ P.371



### ▶ Pulse Motor Type

RCP2  
series

R  
C  
P  
2

	Mini slide type (2-finger)	42mm width	RCP2-GRSS ...	373

	Mini lever type (2-finger)	42mm width	RCP2-GRLS ...	375

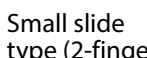
	Small slide type (2-finger)	69mm width	RCP2-GRS ...	377
		74mm width	RCP2-GRM ...	379

	Long stroke type (2-finger)	130~190mm width	RCP2-GRST ...	381

Product Index ①

Slider Type

Product Index ②

Rod type

Product Index ③

Table Type  
Gripper Type/Rotary Type  
Linear Servo Type

Product Index ④

Cleanroom Type  
Dustproof/Splash-Proof Type  
Controllers

R  
C  
P  
2

High-gripping force type  116mm width RCP2-GRHM .. 383  
131mm width RCP2-GRHB ... 385

**NEW**

Small lever type (3-finger)  62mm width RCP2-GR3LS .. 387

Medium lever type (3-finger)  80mm width RCP2-GR3LM .. 389

Small slide type (3-finger)  62mm width RCP2-GR3SS .. 391

Medium slide type (3-finger)  80mm width RCP2-GR3SM .. 393

▶ Servo Motor Type (100/200V)

RCS  
series

R  
C  
S  
2

Long stroke type (2-finger)  104~284mm width RCS2-GR8 ..... 395

## Rotary Type

▶ P.397





▶ Pulse Motor Type

RCP  
series

R  
C  
P  
2

Small vertical type 45mm width RCP2-RTBS/RTBSL ..... 397

Small flat type  72mm width RCP2-RTCS/RTCSL ..... 399

Medium vertical type  50mm width RCP2-RTB/RTBL ..... 401

Medium flat type  88mm width RCP2-RTC/RTCL ..... 403

Large vertical type  76mm width RCP2-RTBB/RTBBL ..... 405

Large flat type  124mm width RCP2-RTCB/RTCBL ..... 407

▶ Servo Motor Type (100/200V)

RCS  
series

R  
C  
S  
2

Hollow motor type  85mm width RCS2-RTC8L/RTC8HL ..... 409  
**NEW** 99mm width RCS2-RTC10L 411  
123mm width RCS2-RTC12L 413

Straight motor type  64mm width RCS2-RT6 .... 415

## Linear Servo Type

▶ P.417





▶ Slider Type

RCL  
series

R  
C  
L

Mini slim type  20mm width RCL-SA1L .... 419  
24mm width RCL-SA2L .... 421  
28mm width RCL-SA3L .... 423

Mini long stroke type  40mm width RCL-SA4L .... 425  
48mm width RCL-SA5L .... 429  
58mm width RCL-SA6L .... 433

Mini multi-slider type  40mm width RCL-SM4L .... 427  
48mm width RCL-SM5L .... 431  
58mm width RCL-SM6L .... 435

▶ Rod Type

RCL  
series

R  
C  
L

Mini slim type  ø16mm RCL-RA1L .... 437  
ø20mm RCL-RA2L .... 439  
ø25mm RCL-RA3L .... 441

CONTINUED ON THE NEXT PAGE



# PRODUCT INDEX ④

## Cleanroom Type

▶ P.443

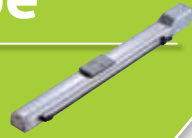

### ▶ Pulse Motor Type

ERC3CR series  
RCP□ CR series

ERC3CR

Controller-Integrated type <b>NEW</b>		50mm width	ERC3CR-SA5C . 445
		73mm width	ERC3CR-SA7C . 447

RCP4CR

Radial cylinder <b>NEW</b>		52mm width	RCP4CR-SA5C . 449
		58mm width	RCP4CR-SA6C . 451
		73mm width	RCP4CR-SA7C . 453

RCP2CR

Steel base		60mm width	RCP2CR-SS7C . 455
		80mm width	RCP2CR-SS8C . 457

High-speed type		80mm width	RCP2CR-HS8C . 459
-----------------	--	------------	-------------------

Mini gripper slide/lever type		42mm width	RCP2CR-GRSS . 461
		42mm width	RCP2CR-GRLS . 463

### ▶ Servo Motor Type (24V)

RCACR series

RCACR

Slider coupled type		40mm width	RCACR-SA4C . 465
		52mm width	RCACR-SA5C . 467
		58mm width	RCACR-SA6C . 469

Slider built-in type		52mm width	RCACR-SA5D . 471
		58mm width	RCACR-SA6D . 473

### ▶ Servo Motor Type (100/200V)

RCS2CR series

RCS2CR

Standard type	<b>NEW</b>	80mm width	RCS3CR-SA8C . 475
---------------	------------	------------	-------------------

Steel base	<b>NEW</b>	80mm width	RCS3CR-SS8C . 477
------------	------------	------------	-------------------

RCS2CR

Standard type		40mm width	RCS2CR-SA4C . 479
		52mm width	RCS2CR-SA5C . 481
		58mm width	RCS2CR-SA6C . 483
		73mm width	RCS2CR-SA7C . 485

Steel Base		60mm width	RCS2CR-SS7C . 487
------------	--	------------	-------------------

Built-in type		52mm width	RCS2CR-SA5D . 489
		58mm width	RCS2CR-SA6D . 491

## Splash-Proof Type

▶ P.493



### ▶ Pulse Motor Type

RCP□ series

RCP4W

Slider type (IP65) <b>NEW</b>		55mm width	RCP4W-SA5C . 495
		62mm width	RCP4W-SA6C . 497
		77mm width	RCP4W-SA7C . 499

Rod type (IP67) <b>NEW</b>		65mm width	RCP4W-RA6C . 501
		75mm width	RCP4W-RA7C . 503

RCP2W

Slider type (IP67)		158mm width	RCP2W-SA16C . 505
--------------------	--	-------------	-------------------

Rod type (IP65)		45mm width	RCP2W-RA4C . 507
		64mm width	RCP2W-RA6C . 509

High thrust type (IP54)		100mm width	RCP2W-RA10C . 511
-------------------------	--	-------------	-------------------

Mini gripper type (Slide/lever) (IP50)		42mm width	RCP2W-GRSS . 513
		42mm width	RCP2W-GRLS . 515

### ▶ Servo Motor Type (24V)

RCAW series

RCAW

Rod coupled type (IP54)		ø32mm	RCAW-RA3C . 517
		ø37mm	RCAW-RA4C . 519

Rod built-in type (IP54)		ø32mm	RCAW-RA3D . 517
		ø37mm	RCAW-RA4D . 519

Rod type w/ side-mounted motor (IP54)		ø32mm	RCAW-RA3R . 517
		ø37mm	RCAW-RA4R . 519

### ▶ Servo Motor Type (100/200V)

RCS2W series

RCS2W

Rod coupled type (IP54)		ø37mm	RCS2W-RA4C . 521
-------------------------	--	-------	------------------

Rod built-in type (IP54)		ø37mm	RCS2W-RA4D . 521
--------------------------	--	-------	------------------

Rod type w/side-mounted motor (IP54)		ø37mm	RCS2W-RA4R . 521
--------------------------------------	--	-------	------------------

# Controllers

## ▶ P.523



Controller/Actuator Correspondence Table .....	525
Explanation of Controller Models .....	527

## ▶ Position Controllers

3-position AC100/200V controller	 PMEC/AMEC .....	537
----------------------------------	---	-----

3-position DC24V controller	 PSEP/ASEP .....	547
-----------------------------	---	-----

Position controller for pulse/servo motor, 8-axis type <b>NEW</b>	 MSEP .....	563
---	---	-----

Controller-integrated actuator controller <b>NEW</b>	 ERC3 (Controller) .....	577
--	---	-----

Controller-integrated actuator controller	 ERC2 (Controller) .....	597
---	---	-----

Controller with DC 24 V high-output driver for pulse motor <b>NEW</b>	 PCON-CA .....	607
---	---	-----

DC24V controller for pulse motor	 PCON .....	623
----------------------------------	--	-----

DC24V controller for servo motor	 ACON .....	631
----------------------------------	--	-----

## Technical References

Considerations when Switching from Air Cylinders .....	A-3
Technical Reference (Service Life and Moment) .....	A-5
Installation Orientations of Actuators .....	A-7
Dimensions of RCP4W Ceiling/Wall-Mounted Specifications .....	A-9
How to Install Detents on Rod Type Mini Actuators .....	A-11
How to Install Linear Rod/RCD Actuators .....	A-12
<b>Custom Order Specifications</b> .....	<b>A-15</b>
<b>Overseas Standards</b> .....	<b>A-17</b>
<b>RoHS Directive/CE Mark/UL Standard Correspondence Table</b> .....	<b>A-18</b>
<b>Discontinued Models and Successor Models</b> .....	<b>A-24</b>
Programs .....	A-26
Explanation of Terms .....	A-29
Model-specific Option Correspondence Table .....	A-37

Simple absolute unit	 CON-ABU .....	641
----------------------	---	-----

AC100/200V controller for servo motor	 SCON-CA .....	643
---------------------------------------	---	-----

**NEW**

Position controller for servo motor, 6-axis type <b>NEW</b>	 MSCON .....	655
---	---	-----

Touch panel teaching pendant for position controller	 CON-PTA .....	557
--	---	-----

PC Software	RCM-101-MW .....	559
	RCM-101-USB .....	559

## ▶ Program Controllers

DC24V controller for pulse motor	 PSEL .....	665
----------------------------------	--	-----

DC24V controller for servo motor	 ASEL .....	675
----------------------------------	--	-----

AC100/200V controller for servo motor	 SSEL .....	685
---------------------------------------	--	-----

AC100/200V multi-axis controller	 XSEL .....	695
----------------------------------	--	-----

Teaching pendant for program controller	 SEL-T .....	713
---	---	-----

PC software	IAI-101-X-MW .....	714
	IAI-101-X-USBMW .....	714

## ▶ Options

24-V power supply	 PS-24 .....	717
-------------------	---	-----

Explanation of Actuator Options .....	A-41
<b>Actuator/Controller Connection Cable Model Number Correspondence Table</b> .....	<b>A-59</b>

## Technical Data for Selection

Push Operation .....	A-71
References for Model Selection (Gripper) .....	A-86
References for Model Selection (Rotary) .....	A-91
Duty .....	A-95
Speed/Acceleration vs. Payload Table .....	A-99
References on Guides .....	A-109

## Information

Our overseas network .....	A-121
Index .....	A-123

# Model Selection

Follow the procedure below to select your ROBO Cylinder.

## 1 Select an Actuator

First, select an actuator. To select a model, choose a product that meets the required specifications such as the weight of the object you want to move with the actuator, distance to be moved, moving speed, and so on. Wide-ranging variations are available, each suitable for a different use environment, shape, etc.

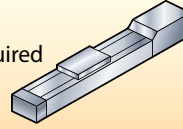

Pre-12

## 2 Select a Controller

Once the actuator is decided, the next step is to select a controller to move the actuator. Controllers that can be used are limited depending on the type of actuator. You can select a controller of a desired I/O type, field network-ready model, etc.



P527

## 3 Select Options

To set up the controller to move the actuator, you need the PC software or teaching pendant as the setting tool. A 24-V power supply may also become necessary.

PC Software Teaching

Teaching Pendant

24-V Power Supply

Refer to the option items on the pages explaining each controller.

P717

## 4 Check "Notes on Specifications in this Catalog"

This section describes the items that require careful attention among those specified in the catalog. Check these items when comparing the specifications of different models.

Pre-39

# 1 Select an Actuator

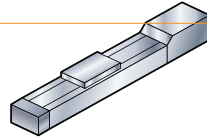

**STEP 1**  
Check the environment

**STEP 2**  
Check the shape

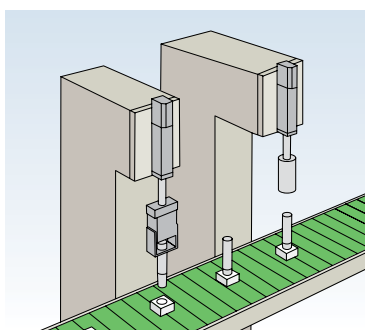

Used in a normal environment

To STEP 2



Used in a cleanroom, etc.

To STEP 4

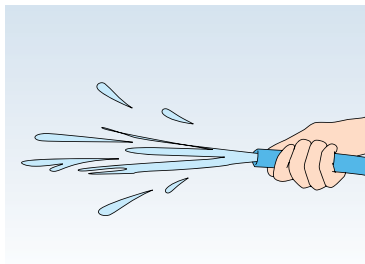

Used in an adverse environment subject to powder dust, water droplets, etc.

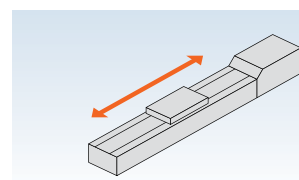

Slider type

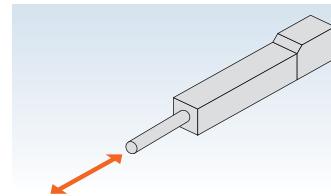

Rod type

To STEP 3

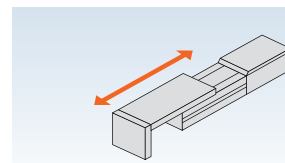
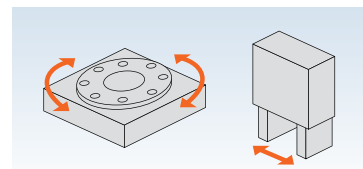

Table Type/  
Arm Type/  
Flat Type



Gripper Type/  
Rotary Type

To STEP 4

# Model Selection

## STEP 3 Select a Motor Type

Motor type	Series name	Feature
Pulse Motor	RCP4 RCP3 RCP2	<ul style="list-style-type: none"> <li>● The pulse motor produces high output at low speed. Suitable for push operation.</li> <li>● The pulse motor is also suitable for measurement applications using a camera, etc., for its excellent stop &amp; hold capability.</li> <li>● Demonstrates higher performance than the 24-V servo motor if combined with Power CON 150 (PCON-CA).</li> <li>● Less expensive than the servo motor.</li> </ul>
	ERC3 ERC2	<p><b>Controller-integrated Type</b></p> <ul style="list-style-type: none"> <li>● The built-in controller design requires no space for a control panel.</li> </ul>
Servo Motor 24V	RCA2 RCA	<ul style="list-style-type: none"> <li>● Unlike the pulse motor, the 24-V servo motor boasts excellent high-speed performance and the payload does not change due to the speed.</li> <li>● Less noisy than the pulse motor.</li> </ul>
Linear Servo Motor	RCL	<ul style="list-style-type: none"> <li>● Maximum acceleration/deceleration of 2G</li> <li>● Maximum horizontal payload of 3.2 kg</li> <li>● Compact linear servo actuator, ideal for moving a light object with a short cycle time.</li> </ul>
Servo Motor 100V/200V	RCS3 RCS2	<ul style="list-style-type: none"> <li>● Largest of the ROBO Cylinder series, these types offer high rigidity and high performance.</li> <li>● Maximum horizontal payload of 80 kg.</li> <li>● Maximum speed of 1800 mm/sec.</li> </ul>
DC Brushless Motor	RCD	<ul style="list-style-type: none"> <li>● Ultra-compact size with cross-section dimensions of □12mm.</li> <li>● 3 strokes of 10mm, 20mm and 30mm to choose from.</li> <li>● Motorized cylinder ideal for replacing a small air cylinder.</li> </ul>

Normal Environment

Slider Type

Rod Type

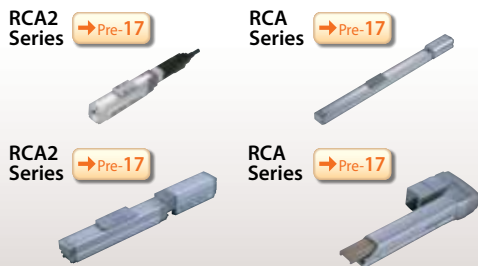

▶  
To  
STEP 4

# Model Selection

**STEP 4**  
 Select a Model  
 from the SPEC List

**STEP 5**  
 Check the Detailed Specifications  
 on Individual Model Pages  
 (Refer to "How to Read the Catalog" on Pre-35.)

Select a model meeting the requirements of STEPS 1 to 3 from the SPEC list provided on Pre-17 to Pre-34.

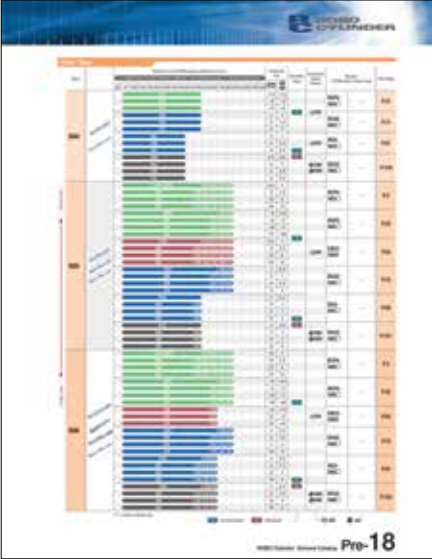

**Normal Environment**

- Slider type ..... Pre-17
- Rod type..... Pre-20
- Table type ..... Pre-25
- Linear servo type ..... Pre-28
- Gripper type ..... Pre-29
- Rotary type..... Pre-30

**Cleanroom Type**  
 ..... Pre-31

**Dustproof/Splash-Proof Type**  
 ..... Pre-33

From the SPEC list, move to the pages explaining each model and check the details to see if the selected model meets the required specifications. Also select a controller according to the actuator.

*\*For the check items, refer to "How to Read the Catalog" on Pre-35. \**

- Basic SPEC
  - Stroke • Speed • Payload
- Allowable overhang length
- Allowable moment
- Cables
- Options



Make a Decision

Select a Controller  
 (Go to P. 527.)

# Basic System Configuration



## Basic Configuration of Positioner Type

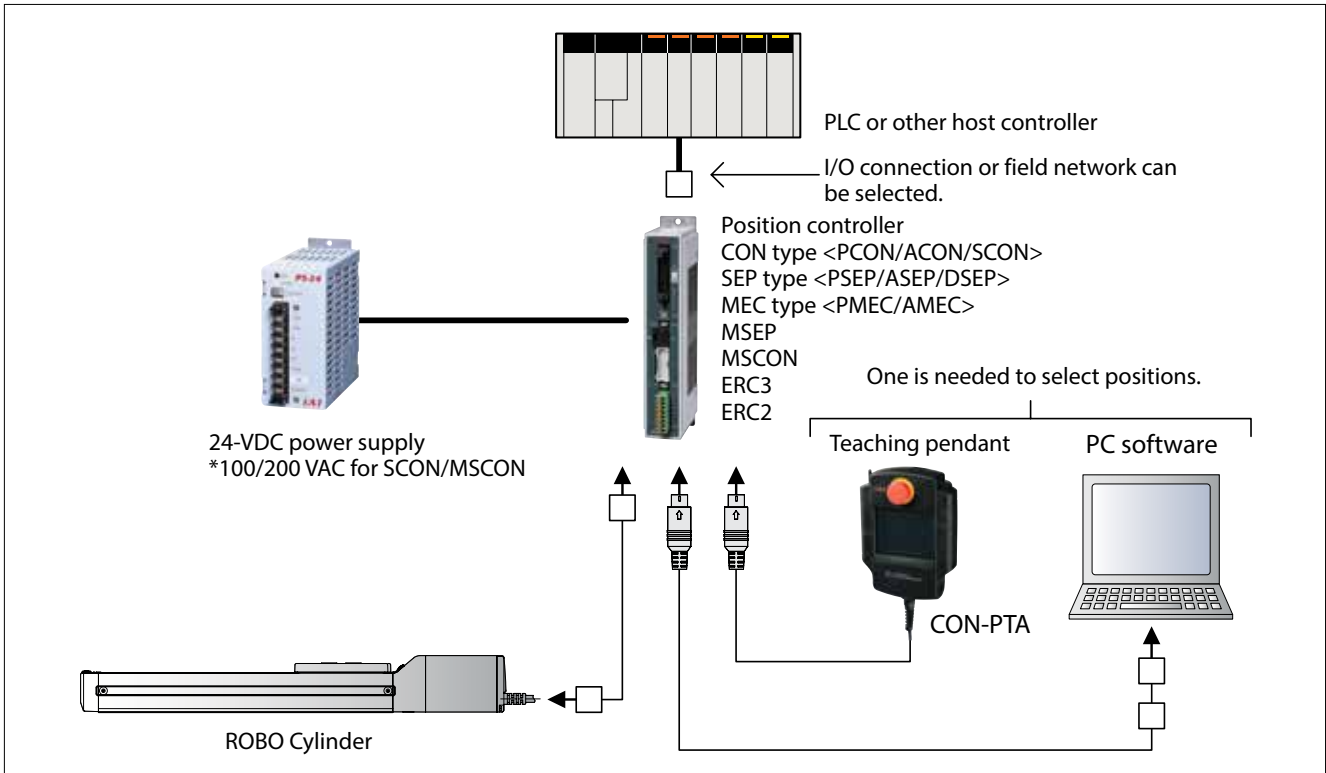

## Basic Configuration of Program Type

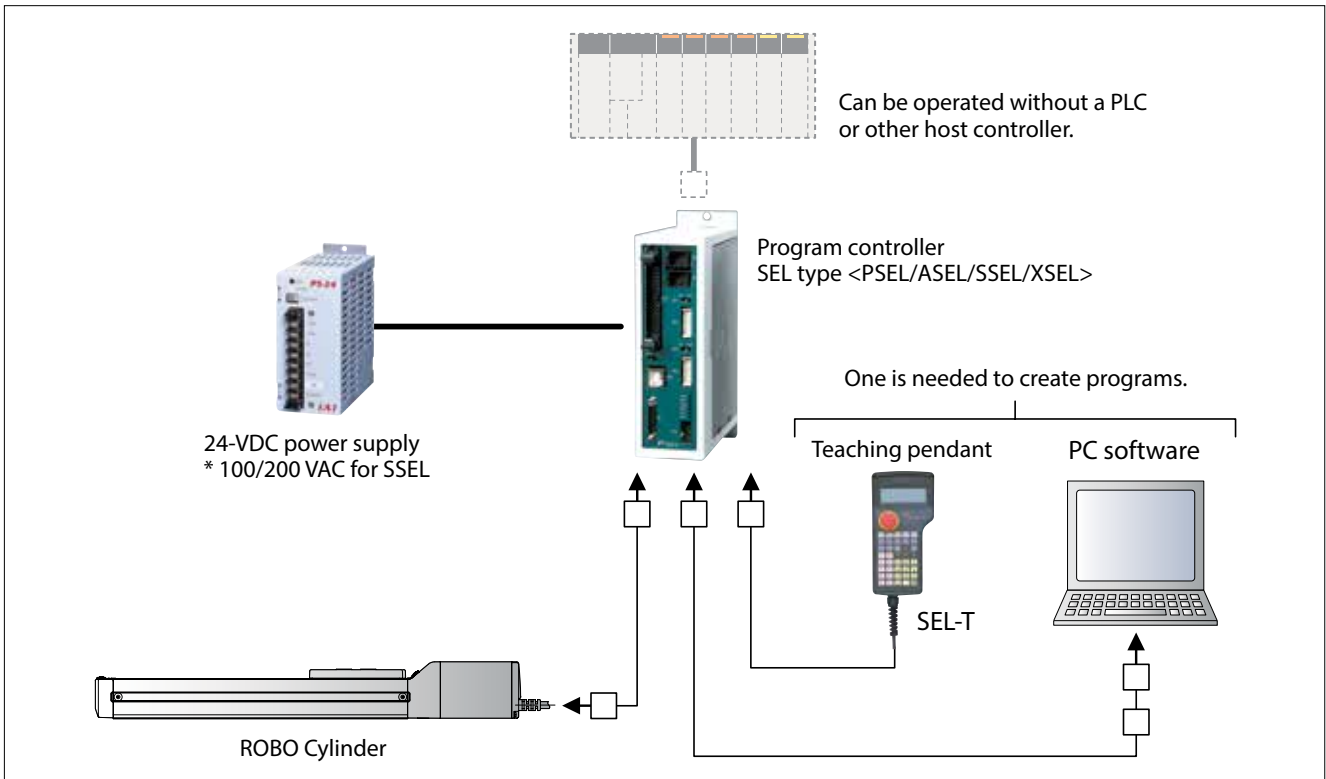



# Model Selection

## Check Specifications

## Slider Type



The slider type is used for transporting and positioning work parts. When selecting a slider-type model, note that the specifications are different when used **horizontally** versus **vertically**.

### [Selection Conditions for Positioning Operation]

Select a model that meets your conditions of use ([1] maximum speed, [2] distance, [3] weight) from the SPEC list provided below.

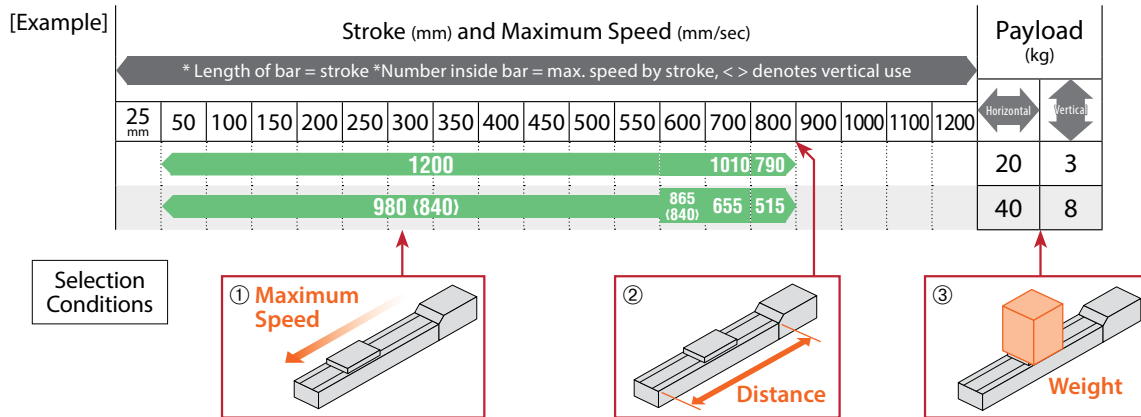

**<Notes on the Table>** (1) The featured models are arranged by size, starting from the smallest one. Larger models are listed later in the list.  
 (2) Each motor type is indicated by a different color.  
 ( Green: Pulse motor , Blue: 24-V servo , Gray: 200-V servo motor , Red: Controller-integrated type )  
 (3) With the pulse motor specification, the payload varies depending on the speed. Check the actual SPEC by referring to the correlation diagram of speed vs. payload provided on the page featuring each model.

**<Notice>** If the work part being transported is significantly overhanging from the actuator, the service life of the guide needs to be considered separately from the actuator's specifications. See "About Service Life and Moment" on page A-5 for details.

### Slider Type

Type	Stroke (mm) and Maximum Speed (mm/sec)														Payload (kg)		Encoder Type	Controller Input Power	Model * □ denotes motor size	See Page	
	25 mm	50	100	150	200	250	300	350	400	450	500	550	600	700	800	900					1000
Small size SA2															0.25	—	I	⊕24V	RCP3-SA2A□	—	P.15
															0.5	—			RCP3-SA2B□	—	P.17
															1	—			RCA2-SA2A□	—	P.67
															0.25	0.25					
Large size SA3															1	0.5	I	⊕24V	RCP3-SA3□	—	P.19
															2	1					
															3	1.5			RCA2-SA3□	—	P.69
															1	0.5					

I = Incremental    A = Absolute    ⊕ = DC    ⊖ = AC

### Slider Type

Type	Stroke (mm) and Maximum Speed (mm/sec)																Payload (kg)		Encoder Type	Controller Input Power	Model		See Page					
	25	50	100	150	200	250	300	350	400	450	500	550	600	700	800	900	1000	1100			1200	Horizontal		Vertical	* □ denotes motor size			
SA4	500																~7.5	~1.5	I	⊖24V	RCP3-SA4□	—	P.21					
	250																~9	~4			RCA2-SA4□	—	P.71					
	125																~11	~8										
	500																2	1	I	⊖24V	RCA-SA4□	—	P.87					
	250																4	1.5										
	125																6	3										
	665																4	1	I	⊖24V	RCA-SA4□	—	P.87					
	330																6	2.5										
	165																8	4.5										
	1060																2.5	0.6	A	⊖100V ⊖200V	RCS2-SA4□	—	P.119					
	665																4	1										
	330																6	2.5										
165																8	4.5											
SA5	1440 (1280)																1225	1045	785	610	6.5	1	I	⊖24V	RCP4-SA5□	—	P.3	
	900																795	665	570	425	330	9			2.5			
	450																395	335	285	215	165	18			6			
	225																195	165	140	105	80	20			12			
	1000																790	610	~4	~0.5	I	⊖24V	RCP3-SA5□	—	P.23			
	600																570	425	330	~6			~2					
	300																285	210	165	~10			~5					
	150																140	105	80	19			~10					
	1120																1115	935	680	510	6.5	1	I	⊖24V	ERC3-SA5C	—	P.55	
	900																805	665	560	405	300	9			2.5			
	450																400	330	280	200	150	18			6			
	225																200	165	140	100	75	20			12			
	1000																790	610	2	0.5	I	⊖24V	RCA2-SA5□	—	P.73			
	600																570	425	330	3			1					
	300																285	210	165	6			1.5					
	150																140	105	80	9			3					
	1300																2	0.5	I	⊖24V	RCA-SA5□	—	P.89					
	800																760	4			1							
	400																380	8			2							
	200																190	12			4							
	1300																2	0.5	A	⊖100V ⊖200V	RCS2-SA5□	—	P.121					
	800																760	4			1							
	400																380	8			2							
	200																190	12			4							
SA6	1440 (1280)																1230	1045	785	615	10	1	I	⊖24V	RCP4-SA6□	—	P.5	
	900																795	670	570	430	335	15			2.5			
	450																395	335	285	215	165	25			6			
	225																195	165	140	105	80	25			12			
	1000																790	610	~4	~0.5	I	⊖24V	RCP3-SA6□	—	P.25			
	600																570	425	330	~6			~2					
	300																285	210	165	~10			~5					
	150																140	105	80	~19			~10					
	600																515	~6	~1.5	I	⊖24V	ERC2-SA6C	—	P.63				
	300																255	12	~3									
	150																125	12	~6									
	1000																790	610	3	0.5	I	⊖24V	RCA2-SA6□	—	P.75			
	600																570	425	330	4			1.5					
	300																285	210	165	7			2					
	150																140	105	80	10			4					
	1300																1160	990	2	0.5	I	⊖24V	RCA-SA6□	—	P.91			
	800																760	640	540	6			1.5					
	400																380	320	270	12			3					
	200																190	160	135	18			6					
	1300																1160	990	2	0.5	A	⊖100V ⊖200V	RCS2-SA6□	—	P.123			
	800																760	640	540	6			1.5					
	400																380	320	270	12			3					
	200																190	160	135	18			6					

\* < > is for vertical use

I = Incremental









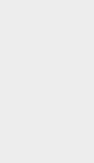

A = Absolute

⊖ = DC

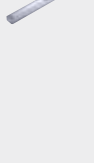
⊖ = AC

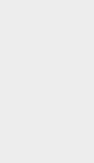
# Model Selection

## Slider Type

Type	Stroke (mm) and Maximum Speed (mm/sec)																Payload (kg)		Encoder Type	Controller Input Power	Model		See Page					
	* Length of bar = stroke * Number inside bar = max. speed by stroke, <> denotes vertical use																max	min			* □ denotes motor size							
	25 mm	50	100	150	200	250	300	350	400	450	500	550	600	700	800	900	1000	1100	1200									
SA4		500																~7.5	~1.5	I	⊖24V	RCP3-SA4□	—	P.21				
		250																~9	~4			RCA2-SA4□	—	P.71				
		125																~11	~8									
		500																2	1	I	⊖24V	RCA2-SA4□	—	P.71				
		250																4	1.5									
		125																6	3									
		665																4	1	I	⊖24V	RCA-SA4□	—	P.87				
		330																6	2.5									
		165																8	4.5									
	1060																2.5	0.6	A	⊖100V ⊖200V	RCS2-SA4□	—	P.119					
	665																4	1										
	330																6	2.5										
	165																8	4.5	A	⊖100V ⊖200V	RCS2-SA4□	—	P.119					
	665																4	1										
	330																6	2.5										
SA5		1440 (1280)																1225 1045 785 610		6.5	1	I	⊖24V	RCP4-SA5□	—	P.3		
		900																795 665 570 425 330		9	2.5							
		450																395 335 285 215 165		18	6							
		225																195 165 140 105 80		20	12							
		1000																790 610		~4	~0.5							
		600																570 425 330		~6	~2							
		300																285 210 165		~10	~5	I	⊖24V	RCP3-SA5□	—	P.23		
		150																140 105 80		19	~10							
		1120																1115 935 680 510		6.5	1							
		900																805 665 560 405 300		9	2.5							
		450																400 330 280 200 150		18	6							
		225																200 165 140 100 75		20	12							
		1000																790 610		2	0.5	I	⊖24V	RCA2-SA5□	—	P.73		
		600																570 425 330		3	1							
		300																285 210 165		6	1.5							
		150																140 105 80		9	3							
		1300																760		2	0.5			I	⊖24V	RCA-SA5□	—	P.89
		800																380		4	1							
400																190		8	2									
200																1300		12	4									
1300																760		2	0.5	A	⊖100V ⊖200V	RCS2-SA5□	—			P.121		
800																380		4	1									
400																190		8	2									
200																1300		12	4									
SA6		1440 (1280)																1230 1045 785 615				10	1	I	⊖24V	RCP4-SA6□	—	P.5
		900																795 670 570 430 335				15	2.5					
		450																395 335 285 215 165		25	6							
		225																195 165 140 105 80		25	12							
		1000																790 610		~4	~0.5							
		600																570 425 330		~6	~2							
		300																285 210 165		~10	~5	I	⊖24V	RCP3-SA6□	—	P.25		
		150																140 105 80		~19	~10							
		600																515		~6	~1.5							
		300																255		12	~3							
		150																125		12	~6							
		1000																790 610		3	0.5			I	⊖24V	ERC2-SA6C	—	P.63
	600																570 425 330		4	1.5								
	300																285 210 165		7	2								
	150																140 105 80		10	4								
	1300																1160 990		2	0.5	I	⊖24V	RCA2-SA6□			—	P.75	
	800																760 640 540		6	1.5								
	400																380 320 270		12	3								
200																190 160 135		18	6									
1300																1160 990		2	0.5	A			⊖100V ⊖200V	RCA-SA6□	—	P.91		
800																760 640 540		6	1.5									
400																380 320 270		12	3									
200																190 160 135		18	6									
1300																1160 990		2	0.5		A	⊖100V ⊖200V		RCS2-SA6□	—	P.123		
800																760 640 540		6	1.5									
400																380 320 270		12	3									
200																190 160 135		18	6									

\* <> is for vertical use

I = Incremental

A = Absolute

⊖ = DC

⊖ = AC

## Check Specifications

## Rod Type

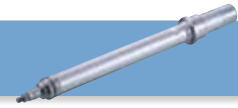

For the rod type, the criteria for selection are different, depending on whether it will be used for **positioning operation** or for **push operation**.

### [Selection Conditions for Positioning Operation]

Select a model that meets your conditions of use ([1] maximum speed, [2] distance, [3] weight) from the SPEC list provided below.

Stroke (mm) and Maximum Speed (mm/sec)									Rated Thrust (N)	Maximum Push Force (N)	Payload (kg)	
25mm	30	50	75	100	150	200	250	300			Horizontal	Vertical
180		200							-	23.1~35.7	1	0.325
100		100							-	46.2~70.6	2	0.625

Selection Conditions

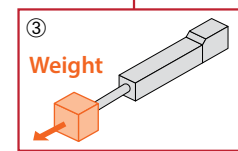
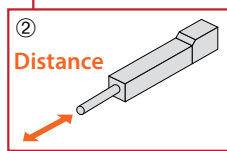
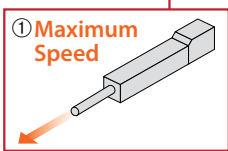

### [Push Operation]

Select a model that meets your conditions of use ([1] distance, [2] push force) from the SPEC list provided below.

Stroke (mm) and Maximum Speed (mm/sec)									Rated Thrust (N)	Maximum Push Force (N)	Payload (kg)	
25mm	30	50	75	100	150	200	250	300			Horizontal	Vertical
180		200							-	23.1~35.7	1	0.325
100		100							-	46.2~70.6	2	0.625

Selection Conditions

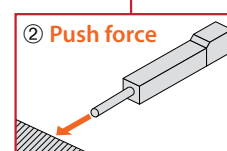
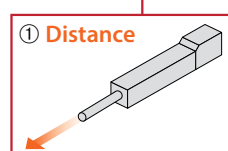

Refer to page A-71 for the details of the push operation.

**<Notes on the Table>** (1) The featured models are arranged by size, starting from the smallest one. Larger models are listed later in the list.  
 (2) Each motor type is indicated by a different color.  
 ( Orange: DC servo motor , Green: Pulse motor , Blue: 24-V servo , Gray: 200-V servo motor , Red: Controller-integrated type )  
 (3) With the pulse motor specification, the payload varies depending on the speed. Check the actual SPEC by referring to the correlation diagram of speed vs. payload provided on the page featuring each model.

# Model Selection

## Rod Type

Type	Stroke (mm) and Maximum Speed (mm/sec)			Rated Thrust (N)	Maximum Push Force (N)	Payload (kg)		Encoder Type	Controller Input Power	Model		See Page
	* Length of bar = stroke * Number inside bar = max. speed by stroke, <> denotes vertical use					Horizontal	Vertical			* □ denotes motor size		
RA1	10mm	20	30	(N)	(N)			I	⊕24V	RCD-RA1D	-	P.195
	300											

## Rod Type

Type	Stroke (mm) and Maximum Speed (mm/sec)									Rated Thrust (N)	Maximum Push Force (N)	Payload (kg)		Encoder Type	Controller Input Power	Model		See Page			
	* Length of bar = stroke * Number inside bar = max. speed by stroke, <> denotes vertical use											Horizontal	Vertical			* □ denotes motor size					
	25mm	30	50	75	100	150	200	250	300	(N)	(N)										
RA2	180		200							-	23.1-35.7	1	0.325	I	⊕24V	RCP3-RA2A□	-	P.155			
	100		100							-	46.2-70.6	2	0.625						(High thrust/)		
	50		50							-	92.4-142.9	4	1.25						(Ball screw)		
	180		200							-	12.6-20.9	0.5	0.2			RCP3-RA2A□	-		-		
	100		100							-	25.2-42.0	1	0.375							(Standard/)	
	50		50							-	50.4-82.8	2	0.75							(Ball screw)	
	180		200							-	6.6-16.1	0.25	0.125			RCP3-RA2A□	-		-		
	100		100							-	13.2-28.3	0.5	0.25							(Standard/)	
	50		50							-	26.4-39.5	1	0.5							(Lead screw)	
	180		280		300						-	15.4-24.1	1			0.325	RCP3-RA2B□		-	-	
	100		200							-	23.1-35.7	2	0.625			(High thrust/)					
	50		100							-	46.2-70.6	4	1.25			(Ball screw)					
	180		280		300						-	6.3-14.3	0.5			0.2	RCP3-RA2B□		-	-	
	100		200							-	12.6-20.9	1	0.375			(Standard/)					
	50		100							-	25.2-42.0	2	0.75			(Ball screw)					
180		280		300						-	50.4-82.8	4	1.5	RCP3-RA2B□	-	-					
100		200							-	4.4-11.9	0.25	0.125	(Standard/)								
50		100							-	6.6-16.1	0.5	0.25	(Lead screw)								
180		280		300						-	13.2-28.3	1	0.5	RCP2-RA2C	-	-					
25		25							-	100	7	2.5	(Ball screw)								
180		200							21.4	-	0.5	0.25	RCA2-RA2A□				-	-			
100		100							42.3	-	1	0.5		(Ball screw)							
50		50							85.5	-	2	1		(Lead screw)							
RN3			200							42.7	-	0.75	0.25	I	⊕24V	RCA2-RN3NA	-	-			
			100							85.5	-	1.5	0.5						(Ball screw)		
			50							170.9	-	3	1						(Lead screw)		
RN4			200							25.1	-	0.25	0.125	I	⊕24V	RCA2-RN4NA	-	-			
			100							50.3	-	0.5	0.25						(Ball screw)		
			50							100.5	-	1	0.5						(Lead screw)		
		220	270	300						33.8	-	2	0.5						RCA2-RN4NA	-	-
		200							50.7	-	3	0.75	(Ball screw)								
		100							101.5	-	6	1.5	(Lead screw)								
		220		300					19.9	-	0.25	0.125	RCA2-RN4NA	-	-						
		200							29.8	-	0.5	0.25				(Ball screw)					
		100							59.7	-	1	0.5				(Lead screw)					
RN5			280		380					89	-	5				1.5	I	100V 200V	RCS2-RN5N	-	-
			250						178	-	10	3	RCA2-RP3NA	-	-						
RP3			280		380					356	-	20				6	I	⊕24V	RCA2-RP3NA	-	-
			250						42.7	-	0.75	0.25	(Ball screw)								
			200						85.5	-	1.5	0.5	RCA2-RP3NA	-	-						
			100						170.9	-	3	1				(Ball screw)					
			200						25.1	-	0.25	0.125				RCA2-RP3NA					
		100						50.3	-	0.5	0.25	(Lead screw)									
		50						100.5	-	1	0.5	(Ball screw)									
RP4		220	270	300					33.8	-	2	0.5	I	⊕24V	RCA2-RP4NA		-	-			
			200						50.7	-	3	0.75							(Ball screw)		
			100						101.5	-	6	1.5				RCA2-RP4NA			-	-	
			220		300				19.9	-	0.25	0.125									(Ball screw)
			200						29.8	-	0.5	0.25									RCA2-RP4NA
		100						59.7	-	1	0.5	(Lead screw)									
RP5			280		380				89	-	5	1.5	I	100V 200V	RCS2-RP5N		-	-			
			250					178	-	10	3	RCA2-RP5N				-			-		
		250						356	-	20	6		RCA2-RP5N	-	-						

\* <> is for vertical use

I = Incremental

A = Absolute

⊕ = DC

⊕ = AC

Pre-21

ROBO Cylinder General Catalog

Sold & Serviced By: **ELECTROMATE**

Toll Free Phone (877) SERV098  
Toll Free Fax (877) SERV099  
www.electromate.com  
sales@electromate.com

### Rod Type

Type	Stroke (mm) and Maximum Speed (mm/sec)									Rated Thrust (N)	Maximum Push Force (N)	Payload (kg)		Encoder Type	Controller Input Power	Model		See Page		
	* Length of bar = stroke * Number inside bar = max. speed by stroke, <> denotes vertical use											Horizontal				Vertical			* □ denotes motor size	
	25mm	30	50	75	100	150	200	250	300			Horizontal	Vertical			Horizontal	Vertical		Horizontal	Vertical
GS3			200							42.7	-	0.75	0.25	I	⊖24V	RCA2-GS3NA (Ball screw)	-	P.209		
			100							85.5	-	1.5	0.5			RCA2-GS3NA (Lead screw)	-			
			50							170.9	-	3	1							
			200							25.1	-	0.25	0.125							
			100							50.3	-	0.5	0.25							
GS4		220	270	300						33.8	-	2	0.5	I	⊖24V	RCA2-GS4NA (Ball screw)	-	P.211		
			200							50.7	-	3	0.75							
			100							101.5	-	6	1.5							
			220	300						19.9	-	0.25	0.125							
			200							29.8	-	0.5	0.25							
GS5				280 (230)	380 (330)					89	-	5	1.5	I	⊖100V ⊖200V	RCS2-GS5N	-	P.263		
				250 (230)	250					178	-	10	3							
					125					356	-	20	6							
										42.7	-	0.75	0.25							
										85.5	-	1.5	0.5							
GD3			200							170.9	-	3	1	I	⊖24V	RCA2-GD3NA (Ball screw)	-	P.213		
			100							25.1	-	0.25	0.125							
			50							50.3	-	0.5	0.25							
			200							100.5	-	1	0.5							
			100							33.8	-	2	0.5							
GD4		220	270	300						50.7	-	3	0.75	I	⊖24V	RCA2-GD4NA (Ball screw)	-	P.215		
			200							101.5	-	6	1.5							
			100							19.9	-	0.25	0.125							
			220	300						29.8	-	0.5	0.25							
			200							59.7	-	1	0.5							
GD5				280 (230)	380 (330)					89	-	5	1.5	I	⊖100V ⊖200V	RCS2-GD5N	-	P.265		
				250 (230)	250					178	-	10	3							
					125					356	-	20	6							
										42.7	-	0.75	0.25							
										85.5	-	1.5	0.5							
SD3			200							170.9	-	3	1	I	⊖24V	RCA2-SD3NA (Ball screw)	-	P.217		
			100		100					25.1	-	0.25	0.125							
			50		50					50.3	-	0.5	0.25							
			200		200					100.5	-	1	0.5							
			100		100					33.8	-	2	0.5							
SD4		240	200	300						50.7	-	3	0.75	I	⊖24V	RCA2-SD4NA (Ball screw)	-	P.219		
			200		200					101.5	-	6	1.5							
			100		100					19.9	-	0.25	0.125							
			200		300					29.8	-	0.5	0.25							
			200		200					59.7	-	1	0.5							
SD5				280 (230)	380 (330)					89	-	5	1.5	I	⊖100V ⊖200V	RCS2-SD5N	-	P.267		
				250 (230)	250					178	-	10	3							
					125					356	-	20	6							
										42.7	-	0.75	0.25							
										85.5	-	1.5	0.5							

Small size

Large size

\* <> is for vertical use

I = Incremental

A = Absolute

⊖ = DC

⊖ = AC

# Model Selection

Rod Type		Stroke (mm) and Maximum Speed (mm/sec)										Rated Thrust (N)	Maximum Push Force (N)	Payload (kg)		Encoder Type	Controller Input Power	Model		See Page				
Type		* Length of bar = stroke * Number inside bar = max. speed by stroke, <> denotes vertical use																Horizontal	Vertical		* □ denotes motor size			
		25 mm	50	100	150	200	250	300	400	500	600	700	800											
RA3		187											–	73.5	~15	~6	I	⊖24V	RCP2-RA3C	–	P.165			
		114											–	156.8	~30	~10			RCA-RA3C	–		P.221		
		500											36.2	–	4	1.5	I	⊖24V						
		250											72.4	–	9	3								
125											144.8	–	18	6.5										
RA4		800											–	56	6	1.5	I	⊖24V	ERC3-RA4C	–	P.179			
		700 695 485											–	93	25	4.5								
		450 345 240											–	185	40	12								
		225 170 120											–	370	40	18								
		600											18.9	–	3	1	I	⊖24V	RCA-RA4C (20W)	–	P.223			
		300											37.7	–	6	2								
		150											75.4	–	12	4								
		600											28.3	–	4	1.5								
		300											56.6	–	9	3	I	⊖24V	RCA-RA4C (30W)	–	P.269			
		150											113.1	–	18	6.5								
		600											18.9	–	3	1			A	⊖100V ⊖200V		RCS2-RA4C (20W)	–	
		300											37.7	–	6	2								
150											75.4	–	12	4										
600											28.3	–	4	1.5										
300											56.6	–	9	3										
150											113.1	–	18	6.5										
SRA4		250											–	112	~25	~9	I	⊖24V	RCP2-SRA4R	–	P.173			
		125											–	224	~35	~15								
		250											41	–	9	3	I	⊖24V	RCA-SRA4R	–	P.233			
		125											81	–	18	6.5								
RA5		800											–	56	6	1.5	I	⊖24V	RCP4-RA5□	–	P.147			
		700											–	93	25	4								
		450											–	185	40	10								
		225											–	370	60	20								
		800 755											63.8	–	12	2	I	⊖100V ⊖200V	RCS2-RA5C (60W)	–	P.271			
		400 377											127.5	–	25	5								
		200 188											255.1	–	50	11.5								
		800 755											105.8	–	15	3.5								
400 377											212.7	–	30	9	A	⊖200V	RCS2-RA5C (100W)	–						
200 188											424.3	–	60	18										
RA6		800 (600)											–	182	20	3	I	⊖24V	RCP4-RA6□	–	P.149			
		700 (560)											–	273	50	8								
		420											–	547	60	18								
		210											–	1094	80	28								
		800 (600)											–	182	13	3	I	⊖24V	ERC3-RA6C	–	P.181			
		700 (560)											–	273	40	8								
		420 400											–	547	55	17.5								
		210 (175) 200 (175)											–	1094	70	25								
		600 500											–	78	~25	~4.5	I	⊖24V	ERC2-RA6C	–	P.183			
		300 250											–	157	~40	~12								
150 125											–	304	40	~18										

\* <> is for vertical use

I = Incremental    A = Absolute    ⊖ = DC    ⊕ = AC

Rod Type		Stroke (mm) and Maximum Speed (mm/sec)											Rated Thrust (N)	Maximum Push Force (N)	Payload (kg)		Encoder Type	Controller Input Power	Model		See Page
		* Length of bar = stroke * Number inside bar = max. speed by stroke, < > denotes vertical use													Horizontal	Vertical			* □ denotes motor size		
		25 mm	50	100	150	200	250	300	400	500	600	700							800	□	
Small size	RA7	450 (400)											-	220	~40	~5	I	⊖24V	ERC2-RA7C	-	P.185
		250 (200)											-	441	~50	~17.5					
		125											-	873	~55	~25					
Large size	SRA7	800											63	-	5	2	I	⊖100V ⊖200V	RCS2-SRA7BD (60W)	-	P.275
		400											127	-	10	5			RCS2-SRA7BD (100W)	-	
		200											254	-	20	10			RCS2-SRA7BD (150W)	-	
		800											103	-	10	3.5			-	-	
		400											207	-	22	9			-	-	
		200											414	-	40	19.5			-	-	
		800											157	-	15	6.5			-	-	
		400											314	-	35	14.5			-	-	
Large size	RA8	300											-	1000	60	40	I	⊖24V	RCP2-RA8 □	-	P.167
		150											-	2000	100	70					
Large size	RA10	250 (167)											-	1500	80	80	I	⊖24V	RCP2-RA10 □	-	P.171
		125											-	3000	150	100					
		63											-	6000	300	150					
Large size	RA13	85 120 125											5106	9800	400	200	I	⊖100V ⊖200V	RCS2-RA13R	-	P.281
		62											10211	19600	500	300			A		

\* < > is for vertical use

I = Incremental

A = Absolute

⊖ = DC

⊖ = AC



# Model Selection

Check Specifications

Table Type



Similar to the rod type, the table type can be used for **positioning operation** and **push operation**. The rod type is recommended for pushing motions, as it exerts stronger force and has more variety.

## [Selection Conditions for Positioning Operation]

Select a model that meets your conditions of use ([1] maximum speed, [2] distance, [3] weight) from the SPEC list provided below.

[Example]

Stroke (mm) and Maximum Speed (mm/sec)									Rated Thrust (N)	Maximum Push Force (N)	Payload (kg)	
25mm	30	50	75	100	150	200	250	300			Horizontal	Vertical
		200							42.7	—	0.75	0.25
		100							85.5	—	1.5	0.5

\*Length of bar = stroke \*Number inside bar = max. speed by stroke, <> denotes vertical use

① Maximum Speed

② Distance

③ Weight

- <Notes on the Table>**
- The featured models are arranged by size, starting from the smallest one. Larger models are listed later in the list.
  - Each motor type is indicated by a different color. (Green: Pulse motor, Blue: 24-V servo, Gray: 200-V servo motor)
  - With the pulse motor specification, the payload varies depending on the speed. Check the actual SPEC by referring to the correlation diagram of speed vs. payload provided on the page featuring each model.

## Table Type

Type	Stroke (mm) and Maximum Speed (mm/sec)									Rated Thrust (N)	Maximum Push Force (N)	Payload (kg)		Encoder Type	Controller Input Power	Model		See Page
	25mm	30	50	75	100	150	200	250	300			Horizontal	Vertical			* □ denotes motor size		
TCA3			200							42.7	—	0.75	0.25	I	⊖24V	RCA2-TCA3NA (Ball screw)	—	P.323
			100							85.5	—	1.5	0.5			RCA2-TCA3NA (Lead screw)	—	
			50							170.9	—	3	1					
			200							25.1	—	0.25	0.125					
			100							50.3	—	0.5	0.25					
TCA4		220	270	300						33.8	—	2	0.5	I	⊖24V	RCA2-TCA4NA (Ball screw)	—	P.325
			200							50.7	—	3	0.75			RCA2-TCA4NA (Lead screw)	—	
			100							101.5	—	6	1.5					
			220	300						19.9	—	0.25	0.125					
			200							29.8	—	0.5	0.25					
TCA5			280	380						89	—	5	1.5	I	⊖100V ⊖200V	RCS2-TCA5N	—	P.351
			250	250						178	—	10	3					
			125							356	—	20	6					

\* <> is for vertical use

I = Incremental    A = Absolute    ⊖ = DC    ⊕ = AC

Table Type

Type	Stroke (mm) and Maximum Speed (mm/sec)								Rated Thrust (N)	Maximum Push Force (N)	Payload (kg)		Encoder Type	Controller Input Power	Model		See Page	
	* Length of bar = stroke * Number inside bar = max. speed by stroke, <> denotes vertical use										Horizontal	Vertical			* □ denotes motor size			
	25mm	30	50	75	100	150	200	250							300			
TWA3	200								42.7	-	0.75	0.25	I	⊖24V	RCA2-TWA3NA (Ball screw)	-	P.327	
	100								85.5	-	1.5	0.5			RCA2-TWA3NA (Lead screw)	-		
	50								170.9	-	3	1						
	200								25.1	-	0.25	0.125						
	100								50.3	-	0.5	0.25						
TWA4	<220> 270 300								33.8	-	2	0.5	I	⊖24V	RCA2-TWA4NA (Ball screw)	-	P.329	
	200								50.7	-	3	0.75			RCA2-TWA4NA (Lead screw)	-		
	100								101.5	-	6	1.5						
	<220> 300								19.9	-	0.25	0.125						
	200								29.8	-	0.5	0.25						
TWA5	280 (230) 380 (330)								89	-	5	1.5	I	⊖100V ⊖200V	RCS2-TWA5N	-	P.353	
	250 (230) 250								178	-	10	3						
	125								356	-	20	6						
TFA3	200								42.7	-	0.75	0.25	I	⊖24V	RCA2-TFA3NA (Ball screw)	-	P.331	
	100								85.5	-	1.5	0.5			RCA2-TFA3NA (Lead screw)	-		
	50								170.9	-	3	1						
	200								25.1	-	0.25	0.125						
	100								50.3	-	0.5	0.25						
TFA4	<220> 270 300								33.8	-	2	0.5	I	⊖24V	RCA2-TFA4NA (Ball screw)	-	P.333	
	200								50.7	-	3	0.75			RCA2-TFA4NA (Lead screw)	-		
	100								101.5	-	6	1.5						
	<220> 300								19.9	-	0.25	0.125						
	200								29.8	-	0.5	0.25						
TFA5	280 (230) 380 (330)								89	-	5	1.5	I	⊖100V ⊖200V	RCS2-TFA5N	-	P.355	
	250 (230) 250								178	-	10	3						
	125								356	-	20	6						
TA3	300 200								-	15	~0.7	~0.3	I	⊖24V	RCP3-TA3□	-	P.303	
	200 (133)								-	22	~1.4	~0.6						
	100 (67)								-	45	~2	~1						
TA4	300								-	25	~1	~0.5	I	⊖24V	RCP3-TA4□	-	P.305	
	200								-	37	~2	~1			RCA2-TA4□	-		
	100								-	75	~3	~1.5						
	300								28	-	1	0.5						
	200								43	-	2	1						
TA5	465 (400)								-	34	~2	~1	I	⊖24V	RCP3-TA5□	-	P.307	
	250								-	68	~4	~1.5			RCA2-TA5□	-		
	125								-	136	~6	~3						
	465 (400)								34	-	2	1						
	250								68	-	3.5	2						
TA6	560 (500)								-	60	~4	~1	I	⊖24V	RCP3-TA6□	-	P.309	
	300								-	110	~6	~2			RCA2-TA6□	-		
	150								-	189	~8	~4						
	560 (500)								17	-	2	0.5						
	300								34	-	4	1.5						
TA7	600 (580)								-	60	~6	~1	I	⊖24V	RCP3-TA7□	-	P.311	
	300								-	110	~8	~2			RCA2-TA7□	-		
	150								-	189	~10	~4						
	600 (580)								26	-	4	1						
	300								53	-	6	2.5						

Small size ↑ Large size ↓

\* <> is for vertical use





I = Incremental A = Absolute

⊖ = DC

⊖ = AC

# Model Selection

## Arm Type/Flat Type

Type	Stroke (mm) and Maximum Speed (mm/sec) * Length of bar = stroke * Number inside bar = max. speed by stroke, <> denotes vertical use	Stroke (mm)								Rated Thrust (N)	Maximum Push Force (N)	Payload (kg)		Encoder Type	Controller Input Power	Model		See Page
		25mm	30	50	75	100	150	200	250			300	Horizontal			Vertical	* □ denotes motor size	
A4R		330								39.2	-	-	2.5	I	⊖24V	RCA-A4R	-	P.357
		165								78.4	-	-	4.5		A	⊖100V ⊖200V	RCS2-A4R	
		330								39.2	-	-	2.5	I	⊖100V ⊖200V	RCS2-A4R	-	
		165								78.4	-	-	4.5					
A5R		400								33.3	-	-	2	I	⊖24V	RCA-A5R	-	P.359
		200								65.7	-	-	4		A	⊖100V ⊖200V	RCS2-A5R	
		400								33.3	-	-	2	I	⊖100V ⊖200V	RCS2-A5R	-	
		200								65.7	-	-	4					
A6R		400								48.4	-	-	3	I	⊖24V	RCA-A6R	-	P.361
		200								96.8	-	-	6		A	⊖100V ⊖200V	RCS2-A6R	
		400								48.4	-	-	3	I	⊖100V ⊖200V	RCS2-A6R	-	
		200								96.8	-	-	6					
F5D		800								63.8	-	-	2	I	⊖100V ⊖200V	RCS2-F5D (60W)	-	P.369
		400								127.5	-	-	5					
		200								255.1	-	-	11.5	I	⊖100V ⊖200V	RCS2-F5D (100W)	-	
		800								105.8	-	-	3.5					
		400								212.7	-	-	9	I	⊖100V ⊖200V	RCS2-F5D (100W)	-	
		200								424.3	-	-	18					

I = Incremental    A = Absolute    ⊖ = DC    ⊕ = AC

## Check Specifications

## Linear Servo Type



The linear servo type is available as a slider type for **positioning operation**, or as a rod type for **push operation**. See below for the selection criteria.

### [Selection Conditions for Positioning Operation]

Select a model that meets your conditions of use ([1] maximum speed, [2] distance, [3] weight) from the SPEC list provided below.

Stroke (mm) and Maximum Speed (mm/sec)								Rated Thrust (N)	Maximum Push Force (N)	Payload (kg)	
25mm	30	40	48	64	100	200	300			Horizontal	Vertical
		420						2	—	0.5	—
			460					4	—	1	—

Selection Conditions

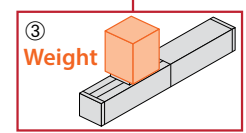
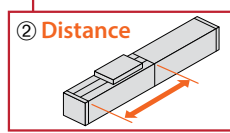
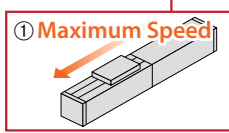

### [Push Operation]

Select a model that meets your conditions of use ([1] distance, [2] push force) from the SPEC list provided below.

Stroke (mm) and Maximum Speed (mm/sec)								Rated Thrust (N)	Maximum Push Force (N)	Payload (kg)	
25mm	30	40	48	64	100	200	300			Horizontal	Vertical
	300							2.5	2	0.5	0.1
		340						5	4	1	0.2

Selection Conditions

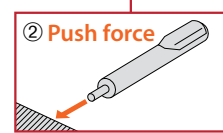
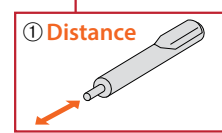

Refer to page A-71 for the details of the push operation.

<Notes on the Table> (1) The featured models are arranged by size, starting from the smallest one. Larger models are listed later in the list.

### Linear Servo Type

Type	Stroke (mm) and Maximum Speed (mm/sec)							Rated Thrust (N)	Maximum Push Force (N)	Payload (kg)		Encoder Type	Controller Input Power	Model		See Page
	25mm	30	40	48	64	100	200			300	Horizontal			Vertical	* □ denotes motor size	
SA1L			420					2	—	0.5	—			RCL-SA1L	—	P.419
SA2L				460				4	—	1	—			RCL-SA2L	—	P.421
SA3L					600			8	—	2	—			RCL-SA3L	—	P.423
SA4L						1200		2.5	—	0.8	—			RCL-SA4L	—	P.425
SA5L							1400	5	—	1.6	—			RCL-SA5L	—	P.429
SA6L								10	—	3.2	—			RCL-SA6L	—	P.433
SM4L						1200		2.5	—	0.8	—	I	⊕24V	RCL-SM4L	—	P.427
SM5L							1400	5	—	1.6	—			RCL-SM5L	—	P.431
SM6L								10	—	3.2	—			RCL-SM6L	—	P.435
RA1L	300							2.5	10	0.5	0.1			RCL-RA1L	—	P.437
RA2L		340						5	18	1	0.2			RCL-RA2L	—	P.439
RA3L			450					10	30	2	0.4			RCL-RA3L	—	P.441

I = Incremental    A = Absolute    ⊕ = DC    ~ = AC

# Model Selection

## Check Specifications

## Gripper type



The gripper type is used for gripping and centering work parts. Gripping is done by a **pushing operation**, and centering is done by a **positioning operation**.

### [Push Operation]

Select a model that meets your conditions of use ([1] distance, [2] grip force) from the SPEC list provided below.

[Example]	Stroke (mm) and Maximum Speed (mm/sec)											Maximum Grip Force		
	8mm	10mm	14mm	20mm	32mm	40mm	60mm	100mm	120mm	200mm	19deg.	180deg.	(N)	
	78											600	14	6.4

Selection Conditions

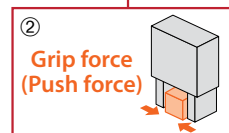
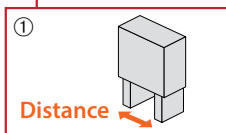

Refer to page A-71 for the details of the push operation.

### [Selection Conditions for Positioning Operation]

Select a model that meets your conditions of use ([1] maximum speed, [2] distance) from the SPEC list provided below.

[Example]	Stroke (mm) and Maximum Speed (mm/sec)											Maximum Grip Force		
	8mm	10mm	14mm	20mm	32mm	40mm	60mm	100mm	120mm	200mm	19deg.	180deg.	(N)	
	78											600	14	6.4

Selection Conditions

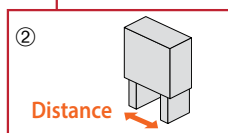
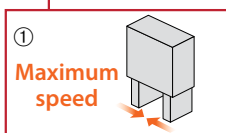

<Notes on the Table> (1) Each motor type is indicated by a different color. ( Green: Pulse motor , Gray: 200-V servo motor )

## Gripper Type

Type	Image	Stroke (mm) and Maximum Speed (mm/sec)											Maximum Grip Force (N)	Encoder Type	Controller Input Power	Model		See Page	
		8mm	10mm	14mm	20mm	32mm	40mm	60mm	100mm	120mm	200mm	19deg.				180deg.	* □ denotes motor size		
GRSS		78												14			RCP2-GRSS	-	P.373
GRLS												600		6.4			RCP2-GRLS	-	P.375
GRS			33.3											21			RCP2-GRS	-	P.377
GRM				36.7										80		⊖24V	RCP2-GRM	-	P.379
GRST								75						20			RCP2-GRST	-	P.381
GRHM								100						125		I	RCP2-GRHM	-	P.383
GRHB								100						200			RCP2-GRHB	-	P.385
GR8														45.1		⊖100V ⊖200V	RCS2-GR8	-	P.395
GR3LS														18			RCP2-GR3LS	-	P.387
GR3LM														51			RCP2-GR3LM	-	P.389
GR3SS			40											22		⊖24V	RCP2-GR3SS	-	P.391
GR3SM				50										102			RCP2-GR3SM	-	P.393

Pre-29

ROBO Cylinder General Catalog

I = Incremental

A = Absolute

⊖ = DC

⊖ = AC

Sold & Serviced By:

**ELECTROMATE**

Toll Free Phone (877) SERV098  
Toll Free Fax (877) SERV099  
www.electromate.com  
sales@electromate.com

## Check Specifications

## Rotary Type



For the rotary type, a model is selected for its **positioning operation** generated by the rotating part.

### [Selection Conditions for Positioning Operation]

Select a model that meets your conditions of use ([1] maximum speed, [2] oscillating angle, [3] inertial moment) from the SPEC list provided below.

[Example]	Oscillating Angle (deg) and Maximum Speed (mm/sec)			Maximum Torque	Allowable Inertial Moment
	300deg.	330	360	(N)	kg·m <sup>2</sup>
		400		0.24	0.0023
		266		0.36	0.0035

Selection Conditions	<p>① Maximum speed</p>	<p>② Oscillating angle</p>	<p>③ Inertial moment</p>
----------------------	------------------------	----------------------------	--------------------------

<Notes on the Table> (1) Each motor type is indicated by a different color. ( Green: Pulse motor , Gray: 200-V servo motor )

### Rotary Type

Type	Image	Oscillating Angle (mm) and Maximum Speed (mm/sec)			Maximum Torque (N)	Allowable Inertial Moment (kg·m <sup>2</sup> )	Encoder Type	Controller Input Power	Model		See Page
		300deg.	330	360					* □ denotes motor size		
RTBS			400 266		0.24 0.36	0.0023 0.0035			RCP2-RTBS	-	P.397
RTBSL				400 266	0.24 0.36	0.0023 0.0035			RCP2-RTBSL	-	
RTCS			400 266		0.24 0.36	0.0023 0.0035			RCP2-RTCS	-	P.399
RTCSL				400 266	0.24 0.36	0.0023 0.0035			RCP2-RTCSL	-	
RTB			600 400		1.1 1.7	0.01 0.015			RCP2-RTB	-	P.401
RTBL				600 400	1.1 1.7	0.01 0.015			RCP2-RTBL	-	
RTC			600 400		1.1 1.7	0.01 0.015	I	⊖24V	RCP2-RTC	-	P.403
RTCL				600 400	1.1 1.7	0.01 0.015			RCP2-RTCL	-	
RTBB			600 400		3 4.6	0.02 0.03			RCP2-RTBB	-	P.405
RTBBL				600 400	3 4.6	0.02 0.03			RCP2-RTBBL	-	
RTCB			600 400		3 4.6	0.02 0.03			RCP2-RTCB	-	P.407
RTCBL				600 400	3 4.6	0.02 0.03			RCP2-RTCBL	-	
RTC8L				750	0.55	0.011			RCS2-RTC8L	-	P.409
RTC8HL				1200 750	0.53 0.85	0.01 0.017			RCS2-RTC8HL	-	P.409
RTC10L				1200 750	1.7 2.8	0.033 0.054	I A	⊖100V ⊖200V	RCS2-RTC10L	-	P.411
RTC12L				800 600	5.2 8.6	0.1 0.17			RCS2-RTC12L	-	P.413
RT6		500			2.4	0.025	I		RCS2-RT6	-	P.415

I = Incremental    A = Absolute    ⊖ = DC    ⊕ = AC

# Model Selection

## Check Specifications

## Cleanroom Type



The cleanroom type is used for transporting and positioning work parts. When selecting a cleanroom type model, note that the specifications are different when used **horizontally** versus **vertically**.

### [Selection Conditions for Positioning Operation]

Select a model that meets your conditions of use ([1] maximum speed, [2] distance, [3] weight) from the SPEC list provided below.

[Example]

Stroke (mm) and Maximum Speed (mm/sec)													Payload (kg)						
* Length of bar = stroke * Number inside bar = max. speed by stroke, < > denotes vertical use													Horizontal	Vertical					
25mm	50	100	150	200	250	300	350	400	450	500	550	600	700	800	900	1000	1100		
665													4	1					
330													6	2.5					

① Maximum speed

② Distance

③ Weight

**<Notes on the Table>** (1) The featured models are arranged by size, starting from the smallest one. Larger models are listed later in the list.  
 (2) Each motor type is indicated by a different color.  
 ( Green: Pulse motor , Blue: 24-V servo , Gray: 200-V servo motor , Red: Controller-integrated type )  
 (3) With the pulse motor specification, the payload varies depending on the speed. Check the actual SPEC by referring to the correlation diagram of speed vs. payload provided on the page featuring each model.

**<Note>** If the work part being transported is significantly overhanging from the actuator, the service life of the guide needs to be considered separately from the actuator's specifications. See "About Service Life and Moment" on page A-5 for details.

### Cleanroom Type

Type	Stroke (mm) and Maximum Speed (mm/sec)													Payload (kg)		Encoder Type	Controller Input Power	Model * □ denotes motor size	See Page	
	* Length of bar = stroke * Number inside bar = max. speed by stroke, < > denotes vertical use													Horizontal	Vertical					
	25mm	50	100	150	200	250	300	350	400	450	500	550	600	700	800	900	1000	1100		
SA4	665													4	1	I A	⊖24V	RCACR-SA4C	-	P.465
	330													6	2.5					
	165													8	4.5					
	665													4	1	I A	⊖100V ⊖200V	RCS2CR-SA4C	-	P.479
	330													6	2.5					
	165													8	4.5					

\* < > is for vertical use

I =Incremental    A =Absolute    ⊖ =DC    ⊕ =AC

### Cleanroom Type

Type	Stroke (mm) and Maximum Speed (mm/sec)													Payload (kg)		Encoder Type	Controller Input Power	Model * □ denotes motor size	See Page					
	* Length of bar = stroke * Number inside bar = max. speed by stroke, < > denotes vertical use													Horizontal	Vertical									
	25mm	50	100	150	200	250	300	350	400	450	500	550	600	700	800					900	1000	1100		
SA5	1440 (1280)													1225	1045	785	610	6.5	1	I	⊖24V	RCP4CR-SA5□	-	P.449
	900													795	665	570	425	9	2.5					
	450													395	335	285	215	18	6					
	225													195	165	140	105	20	12					
	1120													1045	785	610	6.5	1	A	⊖24V	ERC3CR-SA5C	-	P.445	
	900													795	665	570	425	9						2.5
	450													395	335	285	215	18						6
	225													195	165	140	105	20						12
	1300 (800)													760				2	0.5	I		RCACR-SA5C	-	P.467
	800													760				4	1					
	400													380				8	2					
	200													190				12	4					
1300 (800)													760				2	0.5	A	⊖100V ⊖200V	RCS2CR-SA5C	-	P.481	
800													760				4	1						
400													380				8	2						
200													190				12	4						
SA6	1440 (1280)													1230	1045	785	615	10	1	I	⊖24V	RCP4CR-SA6□	-	P.451
	900													795	670	570	430	15	2.5					
	450													395	335	285	215	25	6					
	225													195	165	140	105	25	12					
	1300 (800)													1160 (800)	990 (800)			3	0.5	I	⊖24V	RCACR-SA6C	-	P.469
	800													760	640	540	6	1.5						
	400													380	320	270	12	3						
	200													190	160	135	18	6						
	1300 (800)													1160 (800)	990 (800)			3	0.5	A	⊖100V ⊖200V	RCS2CR-SA6C	-	P.483
	800													760	640	540	6	1.5						
	400													380	320	270	12	3						
	200													190	160	135	18	6						
SA7	1200													1010	790			20	3	I	⊖24V	RCP4CR-SA7□	-	P.453
	980 (840)													865 (840)	655	515	40	8						
	490													430	325	255	45	16						
	245 (210)													215 (210)	160	125	45	25						
	1200													1010	790			17	3	A	⊖24V	ERC3CR-SA7C	-	P.447
	980 (840)													865 (840)	655	515	35	6						
	490													430	325	255	40	14						
	210													160	125		45	22						
	800													640	480			12	3	I	⊖100V ⊖200V	RCS2CR-SA7C	-	P.485
	400													320	240		25	6						
	200													160	120		40	12						

Small size ↑ Large size ↓

\* < > is for vertical use

I = Incremental    A = Absolute    ⊖ = DC    ⊕ = AC





**Dustproof/Splash-Proof Type**

Type	Stroke (mm) and Maximum Speed (mm/sec)														Rated Thrust (N)	Maximum Push Force (N)	Payload (kg)		Encoder Type	Controller Input Power	Model * □ denotes motor size		See Page
	* Length of bar = stroke * Number inside bar = max. speed by stroke, <> denotes vertical use																Horizontal	Vertical			RCP4W- SA5C	RCP4W- SA6C	
	50 mm	100	150	200	250	300	350	400	450	500	550	600	650	700									
SA5	330														-	66.9	5	-					P.495
	165														-	147.9	10	-					
SA6	400														-	82.8	7.5	-	I	⊖24V			P.497
	200														-	179.5	15	-					
SA7	530														-	161.9	10	-					P.499
	265														-	337.9	20	-					
SA16	180														-	N/A	~25	-	I	⊖24V			P.505
	133														-	N/A	~35	-					
RA6	500														-	93	20	3					P.501
	560 (500)														-	185	40	8					
	360														-	370	50	16	I	⊖24V			
RA7	500														-	219	40	7					P.503
	560 (400)														-	437	50	15					
	340														-	875	70	25					
RA4	450 (250)														-	150	~25	~4.5					P.507
	190														-	284	~40	~12					
	125 (115)														-	358	40	~19					
RA6	320 (265)														-	240	~40	~5					P.509
	200														-	470	50	~17.5					
	100														-	800	55	~26	I	⊖24V			
RA10	250 (167)														-	1500	~80	~80					P.511
	125														-	3000	150	~100					
	63														-	6000	300	~150					
RA3	500														36.2	-	4	1.5					P.517
	250														72.4	-	9	3					
	125														144.8	-	18	6.5					
RA4	600														18.9	-	3	1					P.519
	300														37.7	-	6	2					
	150														75.4	-	12	4		⊖24V			
	600														28.3	-	4	1.5					
	300														56.6	-	9	3					
	150														113.1	-	18	6.5	I				
	600														18.9	-	3	1					P.521
	300														37.7	-	6	2					
	150														75.4	-	12	4					
	600														28.3	-	4	1.5		⊖100V ⊖200V			
	300														56.6	-	9	3					
	150														113.1	-	18	6.5					

\* < > is for vertical use

I = Incremental    A = Absolute    ⊖ = DC    ⊕ = AC

# Model Selection

## How to Read the Catalog

\* Refer to Pre-37 and 38 for the detailed explanation of each item.

- 1 Check the Basic SPEC
- 2 • Stroke
- 3 • Payload
- 4 • Speed

## Check the Allowable Overhang Length and Allowable Moment

Model description

CE Mark/RoHS compliance

1 Correlation diagram of speed vs. payload

Notes on Selection

2 Stroke vs. maximum speed

3 Lead vs. payload

Strokes

4 Actuator specifications

5 Options

6 Cables

### RCP4 ROBO Cylinder

## RCP4-SA5C

ROBO Cylinder, Slider Type, Motor Unit Coupled, Actuator Width 52mm, 24-V Pulse Motor

**Model Specification Items:** RCP4 - SA5C - I - 42P - P3

Series: RCP4, Type: SA5C, Encoder type: I, Motor type: 42P, Lead: 20, Stroke: 50, Applicable controller: P3, Cable length: N, Options: Refer to the options table below.

**CE Mark/RoHS compliance:** CE RoHS



**Correlation Diagrams of Speed and Payload:** Horizontal and Vertical graphs showing payload (kg) vs. speed (mm/s) for various lead lengths (Lead 3, Lead 6, Lead 12, Lead 20, Lead 30) at 0.2G and 0.3G acceleration. Operated by the PCON-CA and MSEP-C.

**Notes on Selection:** (1) The maximum payload is the value when operated at 0.2G (0.2G) with some model acceleration. (2) The specific value varies depending on the connected controller and actuator lead. (3) Take note that the maximum payload and maximum speed vary depending on the controller connected to the RCP4.

**Actuator Specifications:**

Model number	Lead (mm)	Connected controller	Minimum payload (N)	Stroke (mm)
RCP4-SA5C-I-42P-20-P3	20	PCON-CA	6.3	1
		MSEP-C	4	0.5(1)
RCP4-SA5C-I-42P-12-P3	12	PCON-CA	9	2.5
		MSEP-C	6	2
RCP4-SA5C-I-42P-6-P3	6	PCON-CA	18	6
		MSEP-C	12	5
RCP4-SA5C-I-42P-3-P3	3	PCON-CA	20	12
		MSEP-C	18	10

**Stroke and Maximum Speed:**

Lead (mm)	Connected controller	50-450 (mm/s)	500 (mm/s)	550 (mm/s)	600 (mm/s)	650 (mm/s)	700 (mm/s)	750 (mm/s)	800 (mm/s)
20	PCON-CA	1440 <1380>	1225	1045	900	785	690	610	530
	MSEP-C	960	800	785	690	610	530	450	370
12	PCON-CA	900	795	665	570	490	425	375	330
	MSEP-C	600	570	490	425	375	330	285	245
6	PCON-CA	450	395	335	285	245	215	185	165
	MSEP-C	300	285	245	215	185	165	145	125
3	PCON-CA	225	195	165	140	120	105	90	80
	MSEP-C	150	140	120	105	90	80	70	60

**Strokes:**

Stroke (mm)	Standard price	Stroke (mm)	Standard price
50	450	500	---
100	---	550	---
150	---	600	---
200	---	650	---
250	---	700	---
300	---	750	---
350	---	800	---

**Cable Length:**

Type	Cable symbol	Standard price
Standard type	P (1m)	---
	S (3m)	---
	M (5m)	---
Special length	X06 (6m) - X10 (10m)	---
	X11 (11m) - X15 (15m)	---
	X16 (16m) - X20 (20m)	---
	R01 (1m) - R03 (3m)	---
Robot cable	R04 (4m) - R05 (5m)	---
	R06 (6m) - R10 (10m)	---
	R11 (11m) - R15 (15m)	---
	R16 (16m) - R20 (20m)	---

**Options:**

Name	Option code	See page	Standard price
Brake	B	→ A-42	---
Optional cable exit direction (top)	CJT	→ A-42	---
Optional cable exit direction (right)	CJR	→ A-42	---
Optional cable exit direction (left)	CJL	→ A-42	---
Optional cable exit direction (bottom)	CJB	→ A-42	---
Non-motor end specification	NM	→ A-52	---
Slider roller specification	SR	→ A-55	---

**Actuator Specifications:**

Item	Description
Drive system	Ball screw ø10mm, rolled C10
Positioning repeatability (*1)	±0.02mm (±0.03mm)
Lost motion	0.1mm or less
Base	Material: Aluminum, white alumite treated
Guide	Linear guide
Dynamic allowable moment (*2)	Ma: 4.9 Nm, Mb: 6.8 Nm, Mc: 11.7 Nm
Allowable overhang	150mm or less in Ma, Mb and Mc directions
Ambient operating temperature, humidity	0 to 40°C, 85% RH or less (Non-condensing)

**3 RCP4-SA5C**

Pre-35 ROBO Cylinder General Catalog

Sold & Serviced By:  
 ELECTROMATE  
 Toll Free Phone (877) SERV098  
 Toll Free Fax (877) SERV099  
 www.electromate.com  
 sales@electromate.com

**5** Check the Cables and Options



**7** Check the Dimensions



**8** Check the Controller

**RCP4** ROBO Cylinder

**Dimensional Drawings**

2D CAD [www.intelligentactuator.com](http://www.intelligentactuator.com)

For Special Orders Appendix P.15

\*1 Connect the motor and encoder cables. \* See page A-59 for details on cables.  
 \*2 During home return, be careful to avoid interference from peripheral objects because the slider travels until the mechanical end.  
 ME: Mechanical end  
 SE: Stroke end

**External dimensions** **7**

**Dimensions and Mass by Stroke**

Stroke	50	100	150	200	250	300	350	400	450	500	550	600	650	700	750	800
L Without brake	279	329	379	429	479	529	579	629	679	729	779	829	879	929	979	1029
L With brake	319	369	419	469	519	569	619	669	719	769	819	869	919	969	1019	1069
A	73	100	100	200	200	300	300	400	400	500	500	600	600	700	700	800
B	0	0	0	1	1	2	2	3	3	4	4	5	5	6	6	7
C	0	0	1	1	2	2	3	3	4	4	5	5	6	6	7	7
D	4	4	6	6	8	8	10	10	12	12	14	14	16	16	18	18
E	4	4	6	6	8	8	10	10	12	12	14	14	16	16	18	18
F	4	4	6	6	8	8	10	10	12	12	14	14	16	16	18	18
G	106	216	266	316	366	416	466	516	566	616	666	716	766	816	866	916
H	0	1	1	1	1	1	1	1	1	1	1	1	1	1	1	1
J	0	35	85	185	185	285	285	385	385	485	485	585	585	685	685	785
K	181	231	281	331	381	431	481	531	581	631	681	731	781	831	881	931
Mass (kg)	1.5	1.6	1.8	1.9	2.1	2.2	2.4	2.5	2.6	2.8	2.9	3.1	3.2	3.4	3.5	3.7
With brake	1.7	1.9	2.0	2.1	2.3	2.4	2.6	2.7	2.9	3.0	3.2	3.3	3.5	3.6	3.7	3.9

**Applicable Controllers**

RCP4 series actuators can be operated with the controllers indicated below. Select the type according to your intended application.

Name	External view	Model number	Features	Maximum number of positioning points	Input power	Power supply capacity	Standard price	Reference page
Positioner type High-output specification		PCON-CA-42PI-□-2-0	Equipped with a high-output driver PID control supported	512 points	DC24V	Refer to P618	—	→ P607
Pulse-train type High-output specification		PCON-CA-42PI-PI-□-2-0	Equipped with a high-output driver Pulse-train input supported	—				
Field network type High-output specification		PCON-CA-42PI-□-0-0	Equipped with a high-output driver Field network supported	768 points				
Solenoid valve multi-axis type PID specification		MSEP-C-□-□-□-2-0	Positioner type based on PID control, allowing up to 8 axes to be connected	3 points	Refer to P572	—	→ P563	
Solenoid valve multi-axis type Network specification		MSEP-C-□-□-□-0-0	Field network-ready positioner type, allowing up to 8 axes to be connected	256 points				

\*□ indicates 10 type (NPN). \*□ indicates number of axis (1 to 8). \*□ indicates field network specification symbol. \*□ indicates 1 (NPN specification) or 7 (PNP specification) symbol.

**Controller** **8**

**IAI** **RCP4-SA5C** **4**

**External dimensions** **7**

**Controller** **8**

# Explanation of Items in This Catalog

## Check the Basic SPEC

### 1 Correlation Diagram of Speed vs. Payload

With pulse motor models (RCP4, RCP3, RCP2, ERC3 and ERC2), the maximum speed varies depending on the payload. Refer to the correlation diagram of speed vs. payload to check if the model selected from the SPEC list meets the required speed and payload. Also note that the specification values of the RCP4 series are different depending on whether the high-output controller (PCON-CA) or non-high-output controller (MSEP) is used.

■ Diagram of Speed vs. Payload

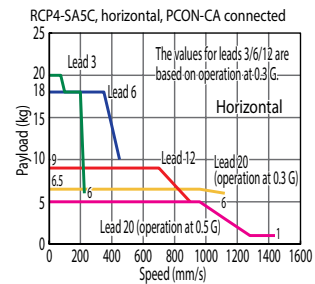

### 2 Stroke vs. Maximum Speed

The longer the stroke, the lower the maximum speed becomes to prevent the ball screw from reaching the dangerous number of revolutions. Refer to the table of stroke vs. maximum speed to check if the selected model meets the required maximum speed.

\* Take note that, if the travel distance is short, the maximum speed may not be reached.

■ Stroke and Maximum Speed

The values in < > apply when the actuator is used vertically. (unit: mm/s)

Lead (mm)	Controller	Stroke (mm)							
		55-450 (50mm)	500	550 (50mm)	600	650	700	750	800
20	PCON-CA	1440<1280>							
	MSEP-C	960							
12	PCON-CA	900	795	665	570	490	425	375	330
	MSEP-C	600			570	490	425	375	330
6	PCON-CA	450	395	335	285	245	215	185	165
	MSEP-C	300			285	245	215	185	165
3	PCON-CA	225	195	165	140	120	105	90	80
	MSEP-C	150			140	120	105	90	80

### 3 Lead vs. Payload

The lead indicates the feed range per one revolution of the ball screw or lead screw. The greater the value of lead, the higher the speed becomes, but the payload decreases. The smaller the value of lead, on the other hand, the greater the payload becomes, but the maximum speed decreases.

■ Lead vs. Payload

Model number	Lead (mm)	Connected controller	Maximum payload		Stroke (mm)
			Horizontal (kg)	Vertical (kg)	
RCP4-SA5C-I-42P-20-①-P3-②-③	20	PCON-CA	6.5	1	50~800 (in 50mm increments)
		MSEP-C	4	0.5 (*)	
RCP4-SA5C-I-42P-12-①-P3-②-③	12	PCON-CA	9	2.5	
		MSEP-C	6	2	
RCP4-SA5C-I-42P-6-①-P3-②-③	6	PCON-CA	18	6	
		MSEP-C	13	5	
RCP4-SA5C-I-42P-3-①-P3-②-③	3	PCON-CA	20	12	
		MSEP-C	16	10	

Explanation of symbols ① Stroke ② Cable length ③ Option(s)

(\*) The value is based on 0.2 G of acceleration.

## 2. Check the Allowable Overhang Length and Allowable Moment

### 4 Actuator Specifications

When selecting an actuator, you must check not only the operating performance, but also the rigidity and life of the actuator. Check the following items in the actuator specification table.

(For the detailed explanation of each item, refer to the glossary of terms at the end.)

Actuator Specifications

Item	Description
Drive method	Ball screw, ø10mm, rolled, C10
Positioning repeatability (*1)	±0.02mm [±0.03mm]
Lost motion	0.1mm or less
Base	Material: Aluminum with white alumite treatment
Guide	Linear guide
Dynamic allowable moment (*2)	4.9 N·m in Ma direction, 6.8 N·m in Mb direction, 11.7 N·m in Mc direction
Allowable overhang length	150mm or less in Ma direction, 150mm or less in Mb/Mc directions
Ambient operating temperature, humidity	0 to 40°C, 85% RH or less (non-condensing)

(\*1) The value in [ ] assumes a lead of 20. (\*2) Based on a traveling life of 5,000 km.

• Drive method Different drive methods are available, such as the ball screw type, lead screw type and belt type, depending on the model.

Drive method	Features
Ball screw	High accuracy, long life
Lead screw	Low cost, low noise
Belt	The maximum speed does not drop at long strokes.

• Positioning repeatability While the positioning repeatability of the ball screw specification is normally 0.02mm, it worsens to ±0.03mm on models with larger screw leads. With the belt specification, the positioning repeatability is considered ±0.1 mm in consideration of the belt elongation, etc.

• Dynamic allowable moment Take note that using the actuator at moments beyond its dynamic allowable moment will significantly shorten the life of the actuator. Check the actual moments that will generate in your specific application according to the calculation methods explained on page A-5 of this catalog.

• Overhang load length Take note that using the actuator at overhang load lengths beyond the specified value may cause abnormal noise or vibration to generate.

# for Model Selection



## 3. Check the Cables and Options

### 5 Options

The options selectable for the model (actuator) on each page are indicated.

For the description of each option, refer to the reference page specified in the table.

③ Option			
Name	Option code	Reference page	Standard price
Brake	<b>B</b>	→ A-42	—
Changed direction for cable exit (top)	<b>CJT</b>	→ A-42	—
Changed direction for cable exit (right)	<b>CJR</b>	→ A-42	—
Changed direction for cable exit (left)	<b>CJL</b>	→ A-42	—
Changed direction for cable exit (bottom)	<b>CJB</b>	→ A-42	—
Non-motor end specification	<b>NM</b>	→ A-52	—
Slider roller specification	<b>SR</b>	→ A-55	—

### 6 Cables

The types of cables for connecting the model (actuator) on each page with its controller are indicated.

Note that the actuator price does not include the cable price.

④ Cable length		
Type	Cable code	Standard price
Standard type	<b>P</b> (1m)	—
	<b>S</b> (3m)	—
	<b>M</b> (5m)	—
Special length	<b>X06</b> (6m) ~ <b>X10</b> (10m)	—
	<b>X06</b> (6m) ~ <b>X15</b> (10m)	—
	<b>X06</b> (6m) ~ <b>X20</b> (10m)	—
Robot cable	<b>X06</b> (6m) ~ <b>R03</b> (10m)	—
	<b>X06</b> (6m) ~ <b>R05</b> (10m)	—
	<b>X06</b> (6m) ~ <b>R10</b> (10m)	—
	<b>X06</b> (6m) ~ <b>R15</b> (10m)	—
	<b>X06</b> (6m) ~ <b>R20</b> (10m)	—

## 4. Check the Dimensions

### 7 External Dimensions

The external dimensions of featured models are specified.

The position of the actuator slider (rod, table, etc.) corresponds to the position at which home return ends.

Shown in the top left-hand corner of the drawing is the symbol indicating whether or not 2D CAD/3D CAD data is available. (CAD data can be downloaded from IAI's website.)

## 5. Check the Controller

### 8 Applicable Controller

The controllers that can be connected (operated) with the model (actuator) on each page are indicated.

For the details of each controller, refer to the reference page.

## 6. Explanation of Other Items

- Model description Model number to be specified when ordering the model (actuator) on each page.
- CE Mark/RoHS compliance This mark is displayed when the model (actuator) on each page is compliant with the CE Mark or RoHS Directive.  
\* Refer to page A-17 for the details of the CE Mark and RoHS Directives.
- Notes on selection The conditions and cautionary items that apply when using the model (actuator) on each page are indicated. Be sure to check these items before using the actuator.

# ROBO Cylinder Series Cautionary Notes

## ■ Notes on Specifications in this Catalog (All Models)

### INDEX

1. Speed.....	Pre-39	10. Rod Type (Rod End Vibration).....	Pre-42
2. Acceleration/Deceleration.....	Pre-40	11. Vertical Setup and Use .....	Pre-42
3. Duty .....	Pre-40	12. Moving the Slider Manually .....	Pre-42
4. Lead Screw .....	Pre-40	13. Actuator Cable/Motor-Encoder Cable..	Pre-43
5. Home .....	Pre-41	14. About the Splash-Proof Actuator .....	Pre-43
6. Encoder Type .....	Pre-41	15. CE Compliance.....	Pre-44
7. Encoder Pulse Number .....	Pre-41	16. Service Life .....	Pre-44
8. Motor .....	Pre-41	17. Warranty.....	Pre-44
9. Actuator Body Precision .....	Pre-42		

## 1. Speed

This refers to the set speed when moving the slider (or rod, arm, output axis) of the actuator.

The slider accelerates from rest to the specified speed, and continues to move at that speed until it decelerates to a stop at the specified target position.

### <Note>

- ❶ For models equipped with a pulse motor (ERC3, ERC2, RCP4, RCP3 and RCP2), the maximum speed changes with the weight of the load being transported. When selecting an actuator, refer to the "Speed vs. Payload" (on each product page).
- ❷ If the axis has a short stroke, or if it has a long stroke but the travel distance is short, the specified speed may not be reached.
- ❸ As the stroke becomes longer, the maximum speed decreases, due to hazardous RPMs. For details, see "■ Stroke vs. Maximum Speed" on each product page.
- ❹ For the RCP2 high-speed slider type (HS8C/HS8R) and belt type, vibration and/or resonance may occur when operated at low speeds. Therefore, use these models at 100mm/s or faster.
- ❺ For position controllers (PMEC/AMEC/PSEP/ASEP/DSEP/PCON-□/ACON-□/SCON-□/MSPEP/MSCON), a minimum speed is set for each actuator. See the instructions manual for each controller.
- ❻ When calculating the time travelled, take into account the time taken to accelerate, decelerate, and settle, as opposed to only the time travelled at the specific speed.

## 2. Acceleration/Deceleration

Acceleration is the rate of change in speed from rest until a specified speed is reached.

Deceleration is the rate of change in speed from the specified speed to a state of rest.

Both are specified in "G" in programs (0.3G = 2940 mm/sec<sup>2</sup>).

\* For rotary type, 0.3G = 2940 degrees/sec<sup>2</sup>

### <Note>

- ❶ Increasing the acceleration (deceleration) speeds up acceleration (deceleration), shortening the travel time. However, caution should be exercised, as excessively high acceleration/deceleration may cause an error or a malfunction.
- ❷ The rated acceleration (deceleration) is 0.3G (0.2G, if the lead is 2.5, 3, or 4, or if used vertically). With the exception of the high-acceleration/deceleration model, use the actuators at or below the rated acceleration.
- ❸ For models such as RCS2-SRA7 and RCS2-RA13R, use the actuator at or below the acceleration (deceleration) mentioned in "Notes on Selection" on the respective product page.

## 3. Duty

The duty indicates the utilization ratio of the actuator (time during which the actuator is operating within one cycle). An overload error may generate if the duty is too high for the load applied to the actuator or the actuator speed or acceleration. Be sure to use the actuator at duties within an appropriate range according to the applicable conditions.

$$\text{Duty} = \frac{\text{Operating time}}{\text{Operating time} + \text{Stopped time}} \quad \%$$

### <Pulse motor>

The pulse motor specification can be operated at a duty of 100%.

Applicable models: RCP2 (CR) (W), RCP3, RCP4, ERC2, ERC3 \*1

\*1: With the ERC3, the duty is limited to suppress heat generation from the motor when the output setting is high.

Refer to page A-95 for details.

### <AC servo motor>

The duty of the AC servo motor is limited according to the operating conditions.

Refer to page A-95 for the duty calculation method for the servo motor.

## 4. Lead Screw

When using a lead screw type actuator (RCP3-SA2□□/RA2□□ and RCA2-□□3NA/□□4NA), note the following:

### <Note>

- ❶ This type is suited for applications with low frequency of use. (As a point of reference, one motion per 10 seconds, 24 hours per day, 240 days per year = approximately 5 years)
- ❷ This is suited for applications in which the payload and load requirements are low. (1 kg or less).
- ❸ Use for applications that do not require a positioning repeatability smaller than ±0.05 mm.
- ❹ Set up in a place that allows for easy maintenance.



# ROBO Cylinder Series Cautionary Notes

## ■ Notes on Specifications in this Catalog (All Models)

### 5. Home

The home is the reference point from which the actuator determines the target position. Note that if the home becomes misaligned, the target position also shifts by the same amount.

#### <Note>

- 1 Home return must be performed for actuators with an incremental encoder upon power-on.
- 2 During home return, the slider (rod, table) moves to the actuator's mechanical end, and then reverses. Therefore, watch for any interference with its surroundings.
- 3 By default, the home is on the motor-side (i.e. the open side on the gripper type, or the left side on the rotary type (looking down at the output shaft.) Optionally, the home can be moved to the opposite side (front side). To change the home direction after the actuator has been delivered, it must be sent back to IAI for adjustment.
- 4 Models without the option code "NM" do not support the non-motor end specification.

### 6. Encoder Type (Incremental/Absolute/Simple Absolute)

There are two types of encoders that can be used in an actuator, "incremental" and "absolute" encoders.

Incremental encoder . . . . . When an incremental encoder is powered off, its coordinate data is erased.

Therefore, home return is necessary each time it is powered back on.

Absolute encoder . . . . . When an absolute encoder is powered off, it uses a battery to store its coordinate data. Therefore, home return is not necessary when it is powered back on. However, note that it cannot be operated once the battery for storing data runs out.

#### <Note>

In addition to the above two types of encoders, there is the "simple absolute" type, which is an incremental encoder with a dedicated simple absolute unit connected to the actuator's controller, for storing its coordinate data. This eliminates the need for home return upon power-on.

Note that the simple absolute actuators (encoders) fall under the incremental type and not the absolute type.

### 7. Encoder Pulse Number

The pulse number of the encoder varies depending on the actuator. See the table below for the pulse number of each actuator.

Series	Type	Encoder Pulse Number
RCP4 RCP3 RCP2	ALL MODELS	800
RCA2	RN□N/RP□N/GS□N/ GD□N/SD□N/TC□N/ TW□N/TF□N	1048
	ALL OTHER MODELS	800

Series	Type	Encoder Pulse Number
RCA	ALL MODELS	800
RCL	SA1L/RA1L	715
	SA2L/RA2L	855
	SA3L/RA3L	1145
RCS3	SRA7BD	3072
RCS2	ALL OTHER MODELS	16384

### 8. Motor

Different motors are used depending on the series.

- ERC3(CR)/ERC2(CR)/RCP4(CR)/RCP3/RCP2(CR): Pulse motor
- RCD: DC brushless motor
- RCA(CR)/RCA2: Servo motor (24V)
- RCS3/RCS2(CR): Servo motor (200V)

Pulse motors and 24V servo motors may exhibit slight vibration when the motor is running while the servo is on.

## 9. Actuator Body Precision

Below are the measures of precision for the body of the slider type ROBO Cylinder. Moreover, the side and bottom surfaces of the actuator's base provide references for the run of the slider, and hence can be used as a guide to ensure parallel mounting of the actuator.

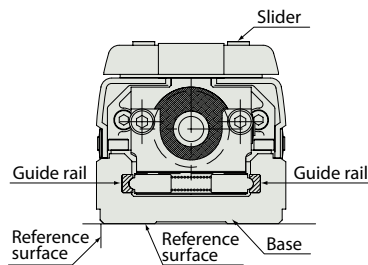

\* Parallelism does not apply to RCP2W-SA16C, due to its sliding guide.

Parallelism: Base Underside & Load Surface (Top Side)

ERC3/ERC2: Within  $\pm 0.2\text{mm/m}$

RCP4/RCP3/RCP2/RCA2/RCA/RCS3/RCS2: Within  $\pm 0.1\text{mm/m}$

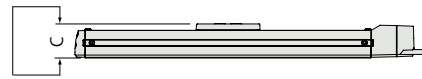

Parallelism When Mounted onto a Frame (Fixed onto a Smooth Surface\*1)

ERC3/ERC2: Within  $\pm 0.2\text{mm/m}$

RCP4/RCP3/RCP2/RCA2/RCA/RCS3/RCS2: Within  $\pm 0.1\text{mm/m}$

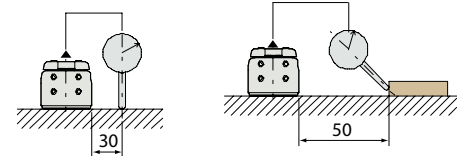

Condition: The above values were measured at 20°C.

\*1: 0.05mm or less deviation from flatness.

## 10. Rod Type (Rod End Vibration)

The standard rod-type actuators do not take into account any vibration or load resistance (The non-rotational accuracy values documented in the actuator specifications are initial values, and the backlash will increase with operation). If the rod vibrates or if the non-rotational accuracy fluctuates, or if there is a force being applied from any direction other than the actuator's linear movement, use the guide-equipped actuator type, or use an external guide.

## 11. Vertical Setup and Use

When using the actuator in a vertical setup, add the optional brake to prevent the slider (or rod) from falling and breaking the machine when the power is turned off or an emergency stop is activated.

However, when mounting a brake-equipped ROBO Cylinder, be aware that the slider (or rod) will not move unless it is connected to the controller and the brake is released.

## 12. Moving the Slider Manually

For ball screws with a low (1, 2.5, 3, 4) lead, the actuator's slider cannot be moved by hand, even if the power and/or servo is off, due to high sliding resistance. To move the slider on a low-lead actuator, use the teaching pendant or the JOG function of the computer software.

# ROBO Cylinder Series Cautionary Notes

## ■ Notes on Specifications in this Catalog (All Models)

### 13. Actuator Cable/Motor-Encoder Cable

The actuator cable is the cable that extends from the rear of the actuator's motor.

Secure the actuator cable in place so that it does not move, as any force exerted on the actuator cable may cause a malfunction.

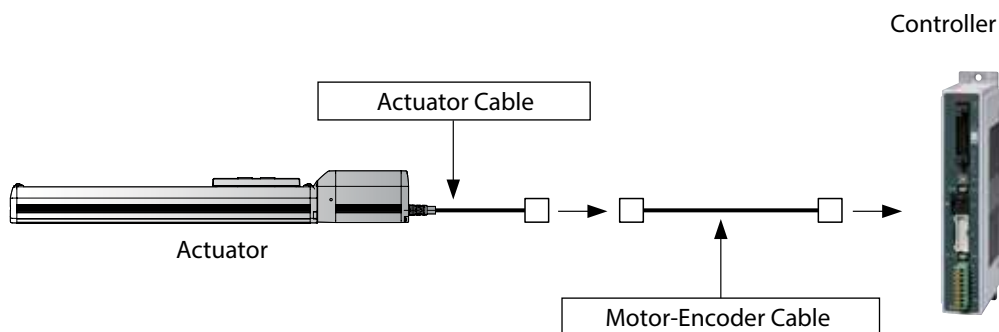

The motor-encoder cable is the cable that connects the actuator and the controller. Depending on the actuator type, some models use a motor-encoder cable that is split into a separate motor cable and an encoder cable, and other models use an integrated motor-encoder cable. Moreover, there are two different specifications of this cable: The standard cable specification and the robot cable specification, which has an outstanding flex resistance.

To use in a cable track, be sure to use the robot cable, using caution not to bend beyond the minimum bend radius R for the cable. (The minimum bend radius R is specified for each cable on the respective pages.)

To check the cable type for each model, see "Table of Actuator-Controller Connection Cable Types" on page A-59.

### 14. About the Splash-Proof Actuator

Although the scope of protective construction of the splash-proof type includes the cable, the connector at the end of the actuator cable is not splash proof. Therefore, secure the end of the actuator cable in a place that is not prone to water spills.

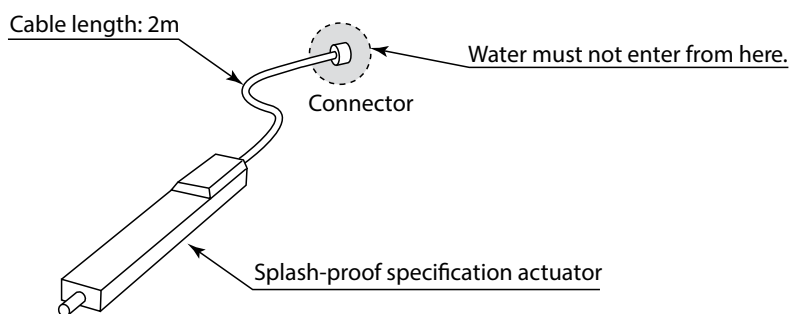

## 15. CE Compliance

---

While the 24-V actuators (RCP4□/RCP3/RCP2□/ERC2/RCA2/RCA/RCD) are CE-compliant based on their standard specification, the 200-V actuators (RCS3□/RCS2□) using a non-standard motor require a special option to ensure compliance. (If the CE option is specified for a 200-V actuator, the safety precaution label will be attached on the actuator.)

For the CE-compliant controllers, refer to “RoHS/CE Mark/UL Standard Compliance Table” on page A-18. Since some actuators cannot be made CE-compliant, also check “RoHS/CE Mark/UL Standard Compliance Table” to see if the desired model is CE-compliant.

## 16. Service Life

---

The service life of the actuator is directly related to the service life of the components that make up the actuator (guide, ball screw, motor, etc.). Moreover, the service life for these components changes significantly depending on the usage requirements.

For example, each guide has an allowable load moment (see page A-5). If the guide is hypothetically used at half the moment of the allowable moment, its service life is eight times more than the specified service life. If used conservatively, it can be used for 10 years or more. Therefore, when selecting a model, it is recommended that you select a model with more head room.

## 17. Warranty

---

The warranty period expires upon elapse of one of the following periods, whichever occurs first.

- 18 months after shipment from IAI factory in Japan
- 12 months after delivery to the location specified
- 2,500 hours after start of operation

IAI will repair free of charge any actuator defects due to craftsmanship or material that may occur during the above warranty period despite use under appropriate conditions. Note, however, that defects resulting from handling or use in any condition or environment not specified in the catalog, operation manual are excluded from the scope of warranty. The warranty covers only the actuator delivered by IAI, and any secondary losses arising from a failure of the delivered product is excluded from the scope of warranty.

The defective actuator must be sent in for repair.

# Application Examples

## Marking Machine

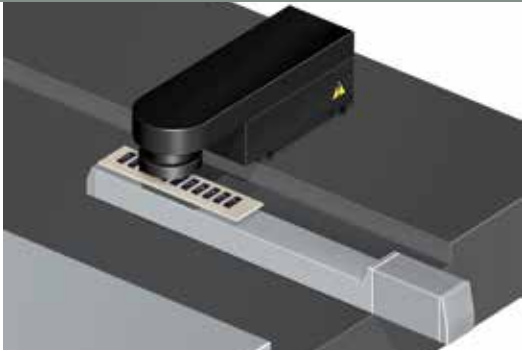

Use ROBO Cylinder in "pitch feed" mode to feed the work parts in a laser marking process.

Actuator ERC3-SA5 (P55) Controller Built-in (P577)

## Liquid Injector

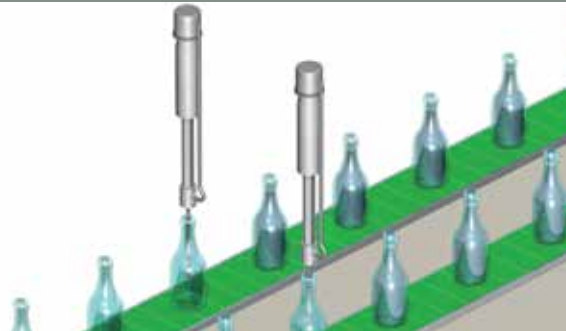

In this equipment, a nozzle is inserted into a shampoo container, and is raised as the shampoo is injected. Speed adjustments are controlled by pulse trains.

Actuator RCA-RA3C (P221) Controller ACON-PL (P631)

## Redirecting a Belt Conveyor

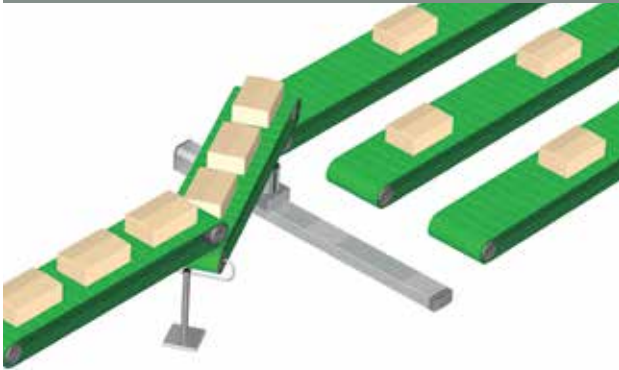

Work parts can be sorted at high speeds.

Actuator RCS3-SS8C (P113) Controller SCON-CA (P643)

## Parts Transfer Machine

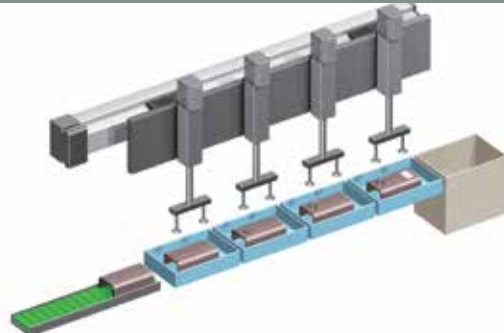

Use ROBO Cylinders for vertical positioning in transfer machines (for moving work parts to a different process line) to make production lines more compact.

Actuator RCA-RA4C (P223) Controller ACON-CY (P631)

## Parts Inspection Machine

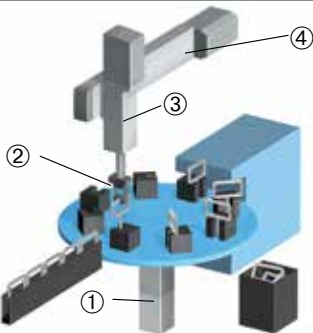

All horizontal/vertical movements, gripping, and rotating operations are driven by ROBO Cylinders. Moreover, controllers can be connected to a field network to reduce wiring.

Actuator ①RCS2-RT6 (P415)  
②RCP2-GRM (P379)  
③RCP4-RA6C (P149)  
④RCP2-SS8C (P41) Controller PCON-SE (P623)  
SCON-CA (P643)

## Aligning Work Parts

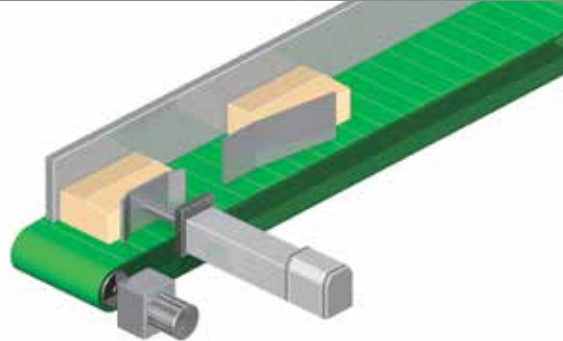

Work parts are aligned by using the push operation to push them against the wall.

Actuator RCP4-RA5C (P147) Controller PCON-CA (P607)

### Pick-and-Place Machine



This low-cost pick-and-place machine uses ROBO Cylinders for the X and the Y axes.

Actuator RCA-SA5C (P89)  
RCA2-GD4NA (P215) Controller ACON-C (P631)  
ASEP-C (P547)

### Disc Stacker

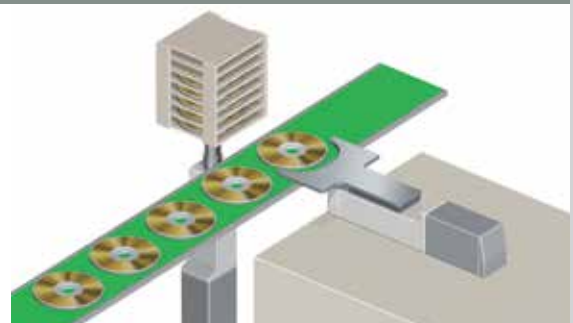

The raising and lowering of the stacker is done by ROBO Cylinder's "pitch feed" function, and the inserting of the discs into the stacker is done by the "acceleration/deceleration" function.

Actuator RCP4-RA6C (P149)  
RCP4-SA6C (P5) Controller PCON-CA (P607)

### Filling Machine

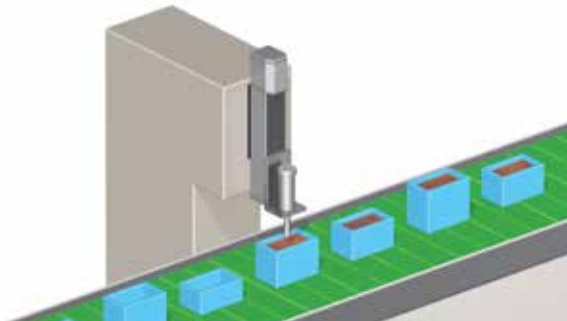

A ROBO Cylinder is used to fill containers that are different in height. With the ability to control multiple positions, multi-product production can be supported.

Actuator RCP3-TA5C (P307) Controller PCON-CA (P607)

### Automotive Parts Inspection Machine



Use ROBO Cylinders in a part inspection line. Drive multiple axes to position and inspect the work parts, and to sort out defects. All axes are controlled by a five-axis XSEL controller.

Actuator RCS2-RA5C (P271) Controller XSEL-P (P695)

### Spacer Insertion Machine

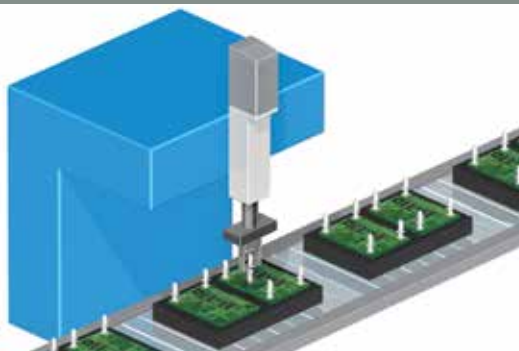

Use the ROBO Cylinder's push operation to insert spacers for printed circuit boards.

Actuator RCP4-RA6C (P149)  
RCP2-GRSS (P373) Controller PCON-CA (P607)  
PSEP-C (P547)

### Press-Fitting Machine

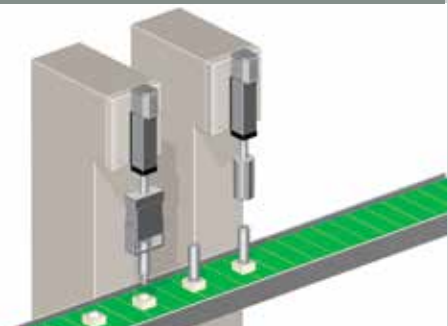

Use ROBO Cylinders for press-fitting and assembling plastic parts. Assembling is done by the positioning of the ROBO Cylinders, while press-fitting is done by the push operation.

Actuator RCP4-RA5C (P147)  
RCP2-RA10C (P171) Controller PCON-CA (P607)  
PCON-CFA (P607)

# Description of Models

Each ROBO Cylinder model is defined by the items (codes) below.

See descriptions below for the meaning of each item. The range of selectable values for each item (e.g. lead, stroke, etc.) is different for each product type. See each type for details.

## [Actuator] Description of Items

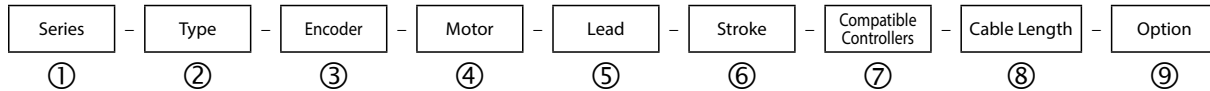

<b>① Series</b>	Indicates the name of the series.																																																					
<b>② Type</b>	<p>Indicates the product type (slider, rod, etc.), material (aluminum, steel, etc.), actuator size (52 mm width, etc.), and motor connection method, using the convention below:</p> <table border="1"> <thead> <tr> <th>Type</th> <th>Material / Form</th> <th>Actuator width</th> <th>Motor connection method</th> </tr> </thead> <tbody> <tr> <td>S (Slider)</td> <td>A (Aluminum)</td> <td>1 (12 width)</td> <td>C (Coupled)</td> </tr> <tr> <td>B (Belt)</td> <td>S (Steel)</td> <td>2 (22/25/28 width)</td> <td>D (Built-in)</td> </tr> <tr> <td>R (Rod)</td> <td>GS (Single guide)</td> <td>3 (30 width)</td> <td>R (Side-mounted)</td> </tr> <tr> <td>H (High-speed)</td> <td>GD (Double guide)</td> <td>4 (40/42/45 width)</td> <td>U (Bottom-mounted)</td> </tr> <tr> <td>T (Table)</td> <td>SD (Slide unit)</td> <td>5 (52/54/55 width)</td> <td>N (Hollow motor)</td> </tr> <tr> <td>A (Arm)</td> <td>N (Nut mounting type)</td> <td>6 (58/64 width)</td> <td>L (Linear motor)</td> </tr> <tr> <td>F (Flat)</td> <td>P (Tapped hole mounting type)</td> <td>7 (60/68 width)</td> <td></td> </tr> <tr> <td>SR (Short rod)</td> <td>C (Compact)</td> <td>7A (width 75, rod 30)</td> <td></td> </tr> <tr> <td></td> <td>W (Wide)</td> <td>7B (width 75, rod 35)</td> <td></td> </tr> <tr> <td></td> <td>F (Flat)</td> <td>8 (80 width)</td> <td></td> </tr> <tr> <td></td> <td></td> <td>10 (100 width)</td> <td></td> </tr> <tr> <td></td> <td></td> <td>16 (158 width)</td> <td></td> </tr> </tbody> </table> <div style="border: 1px solid black; padding: 5px; margin-top: 10px;"> <p>e.g. SA5C</p> <p>Type: Slider</p> <p>Material: Aluminum</p> <p>Actuator width: 52mm</p> <p>Motor: Coupled</p> </div> <p>* Gripper and rotary type ROBO Cylinders have their own naming convention.</p>		Type	Material / Form	Actuator width	Motor connection method	S (Slider)	A (Aluminum)	1 (12 width)	C (Coupled)	B (Belt)	S (Steel)	2 (22/25/28 width)	D (Built-in)	R (Rod)	GS (Single guide)	3 (30 width)	R (Side-mounted)	H (High-speed)	GD (Double guide)	4 (40/42/45 width)	U (Bottom-mounted)	T (Table)	SD (Slide unit)	5 (52/54/55 width)	N (Hollow motor)	A (Arm)	N (Nut mounting type)	6 (58/64 width)	L (Linear motor)	F (Flat)	P (Tapped hole mounting type)	7 (60/68 width)		SR (Short rod)	C (Compact)	7A (width 75, rod 30)			W (Wide)	7B (width 75, rod 35)			F (Flat)	8 (80 width)				10 (100 width)				16 (158 width)	
Type	Material / Form	Actuator width	Motor connection method																																																			
S (Slider)	A (Aluminum)	1 (12 width)	C (Coupled)																																																			
B (Belt)	S (Steel)	2 (22/25/28 width)	D (Built-in)																																																			
R (Rod)	GS (Single guide)	3 (30 width)	R (Side-mounted)																																																			
H (High-speed)	GD (Double guide)	4 (40/42/45 width)	U (Bottom-mounted)																																																			
T (Table)	SD (Slide unit)	5 (52/54/55 width)	N (Hollow motor)																																																			
A (Arm)	N (Nut mounting type)	6 (58/64 width)	L (Linear motor)																																																			
F (Flat)	P (Tapped hole mounting type)	7 (60/68 width)																																																				
SR (Short rod)	C (Compact)	7A (width 75, rod 30)																																																				
	W (Wide)	7B (width 75, rod 35)																																																				
	F (Flat)	8 (80 width)																																																				
		10 (100 width)																																																				
		16 (158 width)																																																				
<b>③ Encoder</b>	<table border="1"> <tr> <td style="background-color: #e0e0e0;">A: Absolute</td> <td>Since the current slider position is retained even after the power is turned off, home return is not required.</td> </tr> <tr> <td style="background-color: #e0e0e0;">I: Incremental</td> <td>Since the position data for the slider becomes lost when the power is turned off, home return is required each time the power is turned on.</td> </tr> </table>	A: Absolute	Since the current slider position is retained even after the power is turned off, home return is not required.	I: Incremental	Since the position data for the slider becomes lost when the power is turned off, home return is required each time the power is turned on.																																																	
A: Absolute	Since the current slider position is retained even after the power is turned off, home return is not required.																																																					
I: Incremental	Since the position data for the slider becomes lost when the power is turned off, home return is required each time the power is turned on.																																																					
<b>④ Motor</b>	<p>Indicates the power output (W) of the motor used in the actuator.</p> <p>All ERC2 series products are labeled as "PM".</p> <p>For the RCP4/RCP3/RCP2/ERC3 series, which use a pulse motor, this code indicates the motor size instead of the power output (e.g. "20P" = 20mm frame size motor).</p>																																																					
<b>⑤ Lead</b>	Indicates the ball screw lead (the distance the slider travels as the ball screw completes one revolution).																																																					
<b>⑥ Stroke</b>	Indicates the stroke (range of motion) of the actuator (in mm or degrees).																																																					
<b>⑦ Compatible controllers (I/O type)</b>	<p>Indicates the type of controllers that can be connected.</p> <p>For the ERC3/ERC2 series, which has a built-in controller, this code indicates the type of I/O (input/output signals).</p>																																																					
<b>⑧ Cable length</b>	Indicates the length of the motor-encoder cables, which connects the actuator and the controller.																																																					
<b>⑨ Options</b>	<p>Indicates the options added to the actuator. (See Technical Reference on page A-37 for details.)</p> <p>*To select multiple options, specify them in alphabetical order (e.g. A3-B-FT)</p> <p>*When specifying a side-mounted motor type, make sure to include the code (ML or MR) to indicate on which side the motor is to be mounted.</p>																																																					

Each model of controller is defined by the items (codes) below.

See descriptions below for the meaning of each item.

Also note that the selection range for each item (I/O type, power-supply voltage, etc.) varies from one controller to another. Check the details on the page featuring each controller.

**[Controller] Description of Items**

■ **Single-axis type** <PMEC, AMEC, PSEP, ASEP, DSEP, PCON, ACON, SCON>

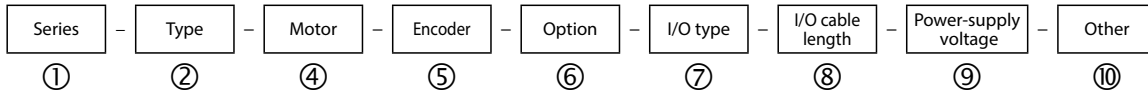

■ **Multi-axis type** <MSEP, MSCON, PSEL, ASEL, SSEL, XSEL>

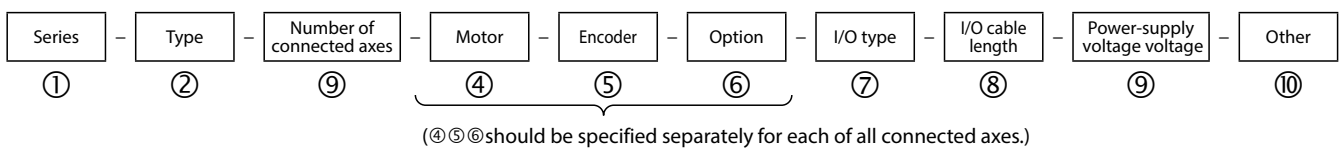

① <b>Series</b>	Name of each controller series. Since the available series vary from one actuator to another, check the connectable controllers on the "Applicable Controllers" table on the page featuring each actuator.
② <b>Type</b>	The type varies depending on the function and connected actuator. Select a type matching your application by referring to the page featuring each controller.
③ <b>Number of connected axes</b>	Number of actuator axes to be connected to the controller.
④ <b>Motor</b>	Motor type of the actuator to be connected to the controller.
⑤ <b>Encoder</b>	Encoder type of the actuator to be connected to the controller.
⑥ <b>Option</b>	Option(s) of the actuator to be connected to the controller (such as high-acceleration/deceleration specification).
⑦ <b>I/O</b>	Type of I/O signals to connect the controller and external equipment.
⑧ <b>I/O cable length</b>	Length of the I/O cable to be supplied when the PIO specification is selected in ⑦ above. If the field network specification is selected, the I/O cable is not supplied and therefore this field is automatically populated by "0."
⑨ <b>Power voltage</b>	Type of the power to be supplied to the controller.
⑩ <b>Other</b>	Whether or not the controller supports the simple absolute specification and whether the high-acceleration/payload specification is available, among others.



# Description of Functions

## Perform Various Functions Through Easy Operations

### 3 Types of Operation Patterns

Switch between three operation patterns depending on the equipment.

#### [Positioning Operation]

Objects attached to the slider axis and rod can be moved to be positioned with a positioning repeatability of  $\pm 0.02$  mm.

<Application> Transporting work part, positioning camera

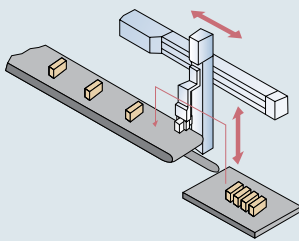

Used in a pick-and-place unit

#### [Pitch Feed Operation]

Instead of positioning by specifying coordinates from the home, the object is moved over a specified distance from the current position.

<Application> Raising/lowering stacker, moving pallet

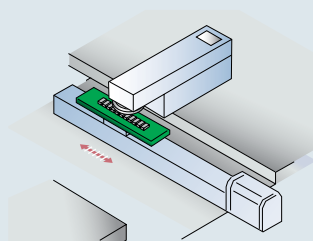

Used for sending work parts in a marking process

#### [Push Operation]

Similar to an air cylinder, a rod can be used to push on a work part continuously.

<Application> Press-fitting work part, clamping

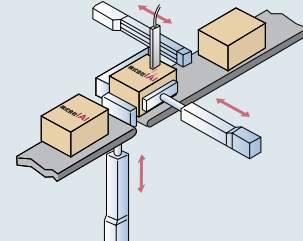

Used for pushing work parts

### 3 Methods of Positioning

Select from 3 types of I/O between the upper-level machine and the controller.

#### [Position Movement]

As with the solenoid valve, movement to preset positions is possible with just an ON/OFF signal.

● Operated by I/O control with the PLC

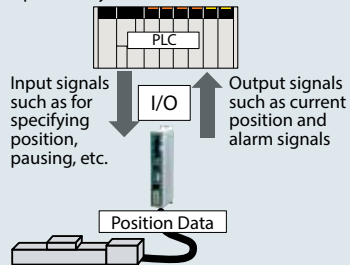

#### [Pulse Train Input]

The destination, speed and acceleration can be freely controlled without inputting the destination beforehand.

● Operated by pulse trains from the PLC and I/O control

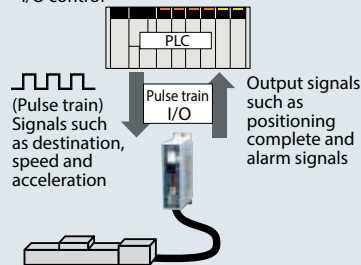

#### [Field Network]

Movement can be instructed via a network, such as DeviceNet and CC-Link. Work parts can be moved by specifying the position, or by directly specifying the coordinates.

● Operated from the PLC via network

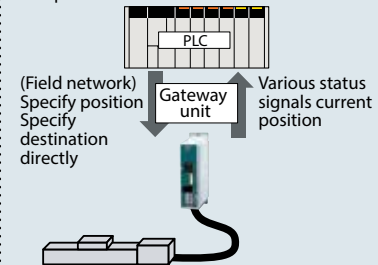

### No Sensor Necessary with Zone Signal

You can set any zone within the stroke, and when the slider enters the zone, the signal is output. This is effective for outputting signals at a specific position, such as in painting, for example, (up to 2 zones can be specified). In addition, as a new feature, P-Zone signals can be set per position. Although the output signal is the same, a zone range of up to 256 points can be set.

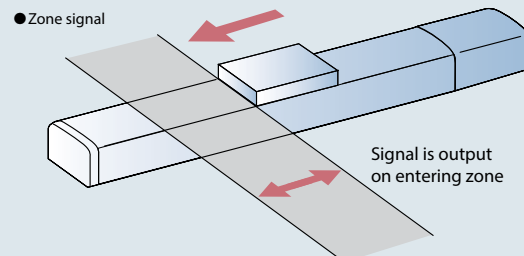

## Positioning Operation

Objects attached to the slider axis and rod can be moved to be positioned with a positioning repeatability of  $\pm 0.01\text{mm}$  to  $\pm 0.1\text{mm}$  (\*).

(\*). Varies depending on a model.

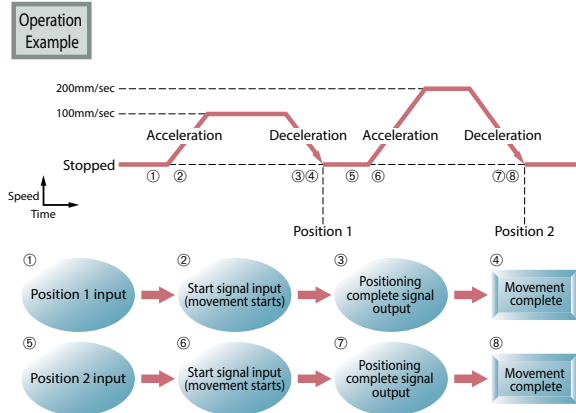
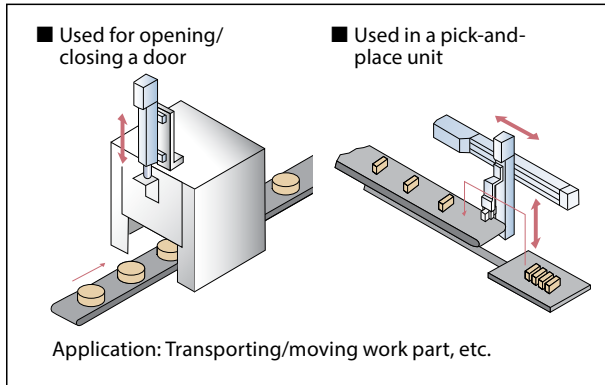

### [Features]

- Capable of positioning up to 512 points.
- Set speed and acceleration/deceleration per position.
- The positioning complete signal can be output at any position ahead of the specified position, depending on the positioning band setting.
- Acceleration and deceleration can be set separately.
- Speed can be changed in transit without stopping.

### Position Data Table

(set by the teaching pendant or PC software)

No.	Position (mm)	Speed (mm/sec)	Acceleration (G)	Deceleration (G)	Push (%)	Positioning band (mm)
1	100	100	0.3	0.3	0	10
2	200	200	0.3	0.3	0	20

<PMEC, AMEC, PSEP, ASEP and DSEP can be operated with the same signals as the solenoid valve>

### ■ Operating Method

PMEC, AMEC, PSEP, ASEP and DSEP can be operated with the same signals as the solenoid valve in air cylinders. There are two types of solenoid valves, the single solenoid and the double solenoid; and both are supported.

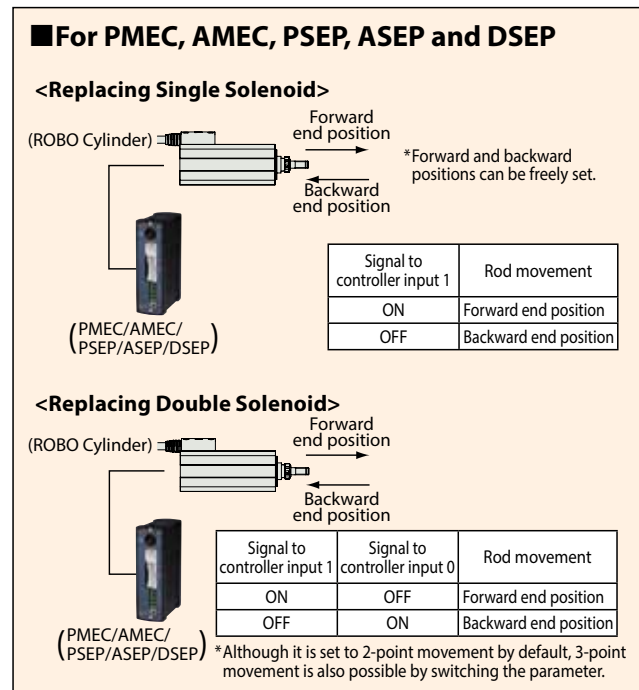
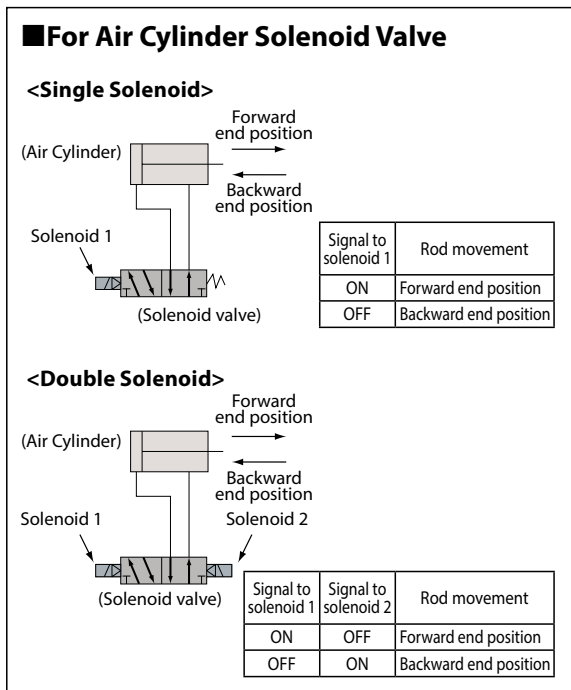

# Description of Functions

## Pitch Feed Function (Incremental Function)

In addition to positioning by specifying coordinates from the home, the work part can be moved over a specified distance from the current position.

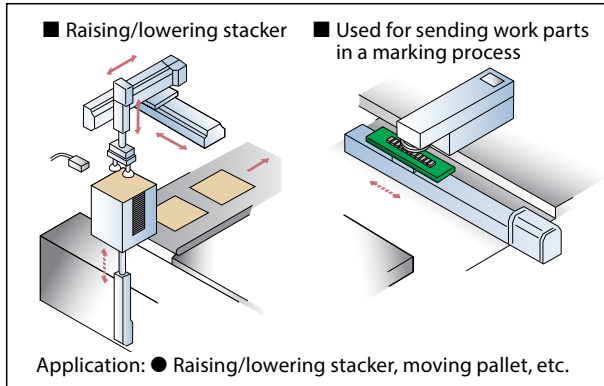

### [Features]

- Repeated movements with even spacing can be performed using one position data, instead of setting multiple positions.
- The pitch can be easily set in the position data table.

(Teaching Pendant)  
"=" is displayed in pitch feed mode.

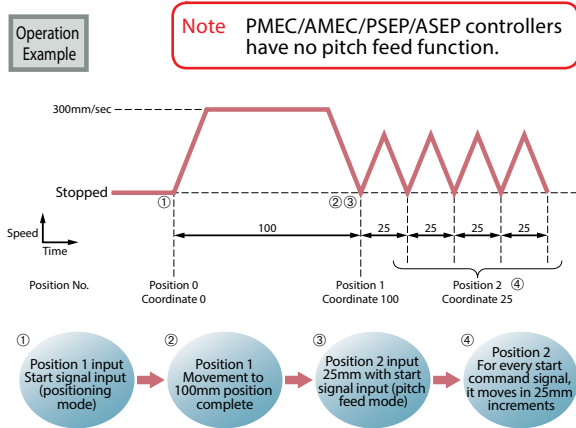

### Position Data Table

(set by the teaching pendant or PC software)

No.	Position (mm)	Speed (mm/sec)	Acceleration (G)	Deceleration (G)	Push (%)	Positioning band (mm)
1	100	300	0.3	0.3	0	0.1
2	= 25	300	0.3	0.3	0	0.1

## Push Operation

Similar to an air cylinder, a rod can be used to push on a work part continuously.

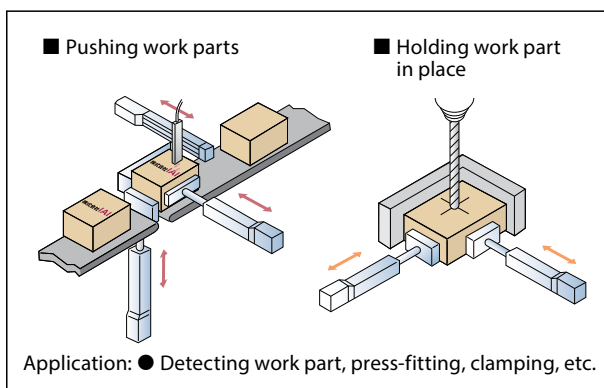

### [Features]

- Since the positioning complete signal is output when the actuator pushes against the work part, you can use it with the zone signal to sort work parts.
- The force against the work part (push force) can be adjusted by changing the setting in the position data table.

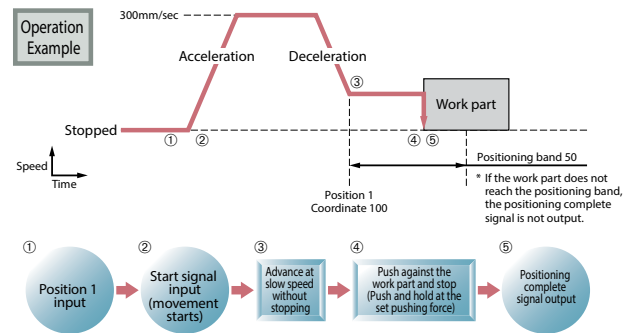
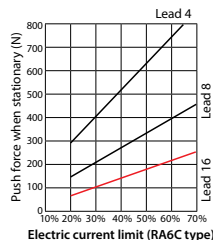

### Position Data Table

(set by the teaching pendant or PC software)

No.	Position (mm)	Speed (mm/sec)	Acceleration (G)	Deceleration (G)	Push (%)	Positioning band (mm)
1	100	300	0.3	0.3	50	0.1

**Note:** The accuracy of the stationary push force is not guaranteed. Please use it only as a rough estimate. Please note that if the push force is too small, the push operation may not be completed properly due to sliding resistance.

## ■ Changing Speed During Movement

Since the speed can be changed from any position during the movement, the takt time can be effectively reduced through multi-tasking.

## ■ Pause Input

By setting an interlock (to prevent interference) with the peripherals, the slider slows down to a stop when the pause input is cut. Once the pause input turns ON again, the remaining motion is resumed.

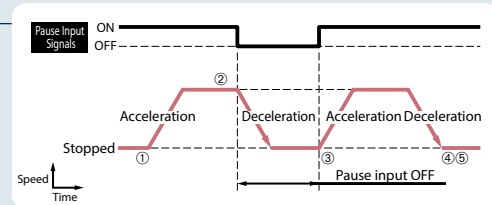

## ■ Zone Output

During movement, you can output a signal at an arbitrary position (whose range is set by a parameter). This can be used to set a danger zone or to reduce takt time.

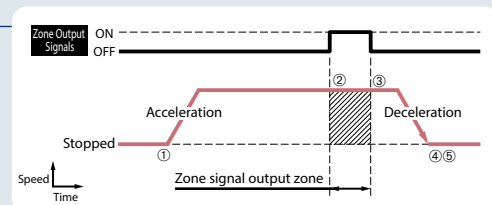

## ■ Capable of Controlling Speed and Acceleration/Deceleration

Speed and acceleration/deceleration can be set for each position. By starting and stopping slowly and moving at a high-speed in between, the takt time can be effectively reduced.

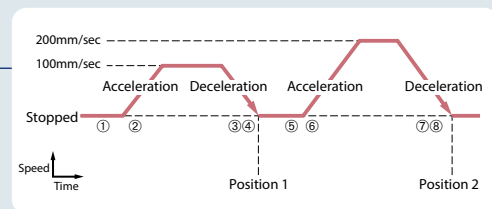

## ■ Complete-Stop and Full-Servo Control Methods

In a pulse motor, you can use the complete-stop method to eliminate vibrations by increasing the current when stationary, or the full-servo method, in which the current is dropped to 1/2 to 1/4 of the complete-stop method to reduce power consumption.

## ■ Auto Servo OFF Method

After the positioning is complete, the servo can be turned OFF automatically after a fixed time has passed. Since no retention current is output, power consumption can be reduced. When the move command is received from the PLC, the servo turns ON and the movement starts.

## ■ Simple Absolute Unit

A simple absolute unit retains the data from the encoder while the power is OFF. When attaching to PCON, ACON, PSEL, and ROBONET, these controllers can be used as simple absolute units to eliminate the need for home return.



# CT Effects of Motorized Actuators

The "CT Effects" refers to an increase in the production volume per unit time resulting from a shorter cycle time and reduced choco tei (frequent downtimes), which in turn is achieved by replacing the components of automated equipment from air cylinder-based ones to motorized actuator-based ones.

Higher unit production volume leads to various benefits, such as less equipment investment and less labor cost required for operating the equipment, etc.

(CT stands for "Cycle Time" and "Choco Tei.")

## CT Effect 1 Shorter Cycle Time

A shorter cycle time of production equipment is expected to cut the equipment investment and labor cost, as illustrated below.

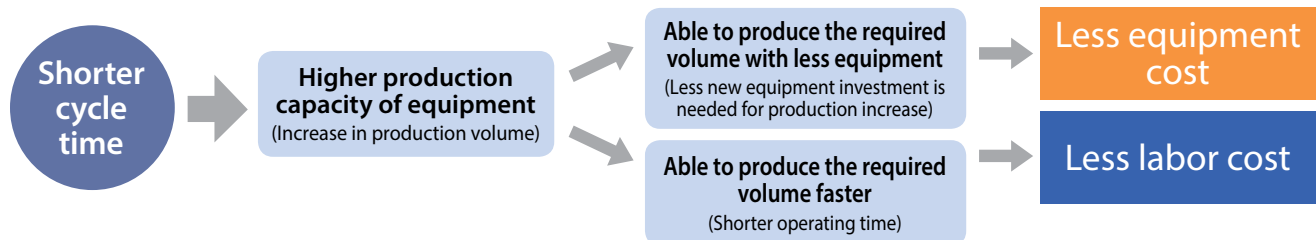

## Why ROBO Cylinders Are Faster

### (1) Delayed start of movement

Air cylinders are subject to a delay of approx. 0.1 sec at the start of movement. This delay corresponds to the time needed for the solenoid valve to open and air to travel through the pipe and enter the cylinder to raise the pressure.

### (2) Not much room to raise maximum speed

With air cylinders, excessively raising the speed increases the shock at the end of stroke, potentially causing choco tei.

With ROBO Cylinders boasting smooth acceleration/deceleration, on the other hand, the maximum speed can be raised.

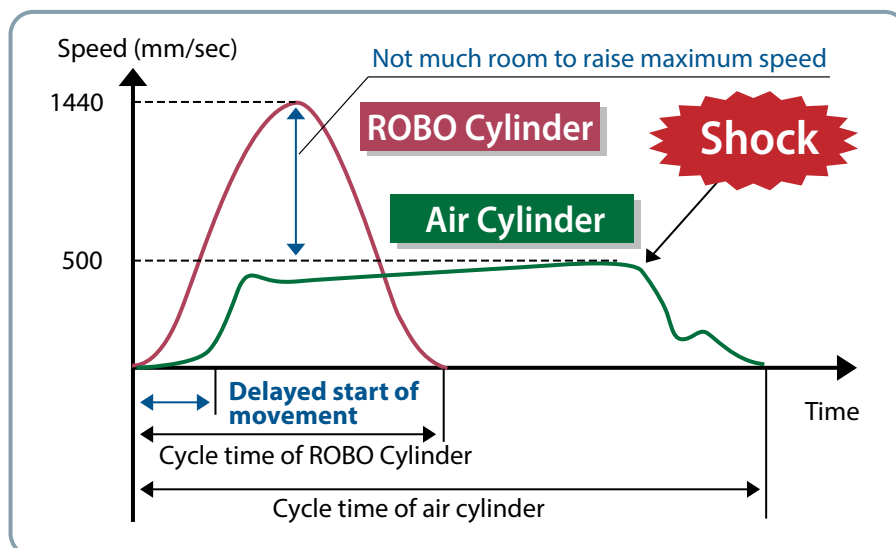

# CT Effects

Shorter Cycle Time Less Choco Tei

## CT Effect 2 Less Choco Tei

By reducing the choco tei of production equipment, equipment investment and labor cost will likely drop, as illustrated below.

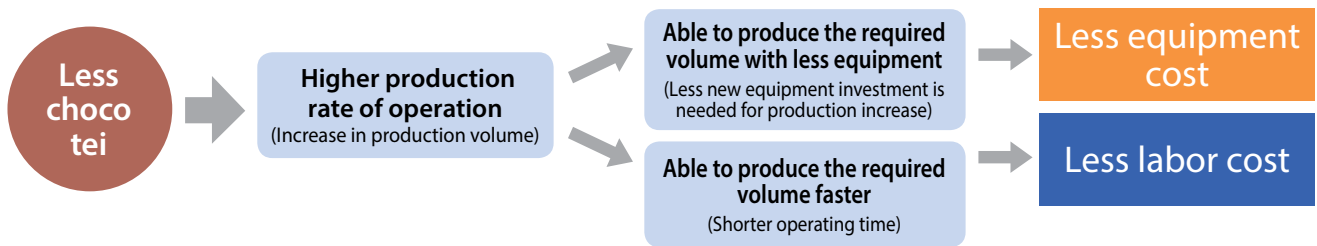

## Causes of Choco Tei

“Choco tei” is a phenomenon accompanied by stopped or idling equipment due to a temporary problem.

Various factors can be considered when it comes to choco tei. An investigation into the causes of choco tei relating to an air cylinder found the following:

The auto switch is responsible for the largest number of choco tei. In particular, as shown in the figure on the right, the shock generating at the end of stroke of an air cylinder causes the auto switch brackets to gradually shift and eventually change the switch positions. When the auto switches shift and the operating timing of the system change, the equipment may stop.

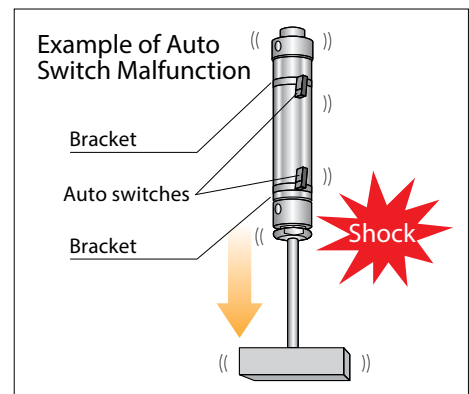

### Cause Analysis of Choco Tei Due to An Air Cylinder

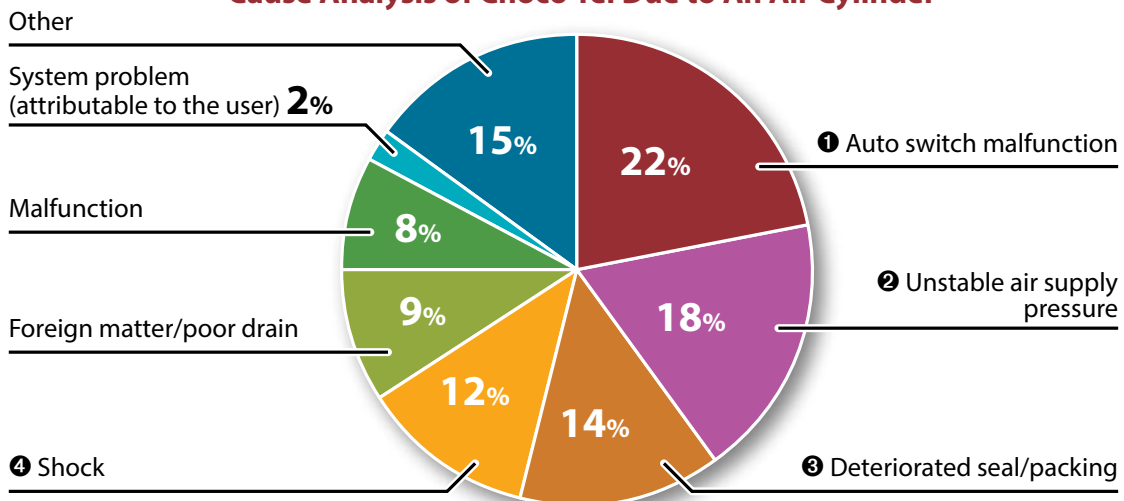

<IAI's internal investigation results>